

User Manual

3-5.5KVA INVERTER



Version : 3.0

CONTENTS

1. ABOUT THIS MANUAL	2
1.1 Purpose	2
1.2 Scope	2
1.3 Safety Instructions	2
2. INTRODUCTION.....	2
2.1 Features	3
2.2 Basic System Architecture	3
2.3 Product Overview.....	4
3. WIFI operation steps	5
4. INSTALLATION.....	6
4.1 Unpacking and Inspection.....	6
4.2 Preparation	6
4.3 Installation Sites Selection	6
4.4 Battery Connection	6
4.5 AC Input/Output Connection	7
4.6 PV Connection.....	8
4.7 Final Assembly	9
4.8 Communication Connection	9
5. OPERATION	10
5.1 Power ON/OFF	10
5.2 Operation and Display Panel	10
5.3 LCD Display Icons	11
5.4 LCD Setting	13
5.5 Parallel function operation instructions.....	16
5.6 Fault Reference Code.....	20
5.7 Warning Indicator.....	21
6.TROUBLE SHOOTING	21
7. SPECIFICATIONS	24
Table 1 Solar Mode Specifications	24
Table 2 Line Mode Specifications.....	25
Table 3 Charge Mode Specifications	26
Table 4 Inverter Mode Specifications	27

1. ABOUT THIS MANUAL

1.1 Purpose

This manual describes how to assemble, install, operate the units and how to troubleshoot of this unit. Please read this manual carefully before installation and operation. Keep this manual for future reference.

1.2 Scope

This manual provides safety guidelines of installation, and the information on tools and wiring.

1.3 SAFETY INSTRUCTIONS



WARNING: This chapter contains important safety and operating instructions. Read and keep this manual for future reference.

1. Read and follow all installation, operation, and maintenance information carefully before using the product.
2. **CAUTION:** To reduce risk of injury, charge only deep-cycle lead acid type rechargeable batteries. Other types of batteries may burst, causing personal injury and damage.
3. Do not disassemble the unit personally. Take it to a qualified service center to repair.
4. To reduce risk of electric shock, disconnect all wiring before attempting any maintenance or cleaning, turning off the unit will not reduce this risk.
5. **WARNING :** Disconnecting all power supply before any maintaining or cleaning, please note that if you only turn off the unit are not safe enough.
6. **WARNING:** Only qualified service persons are allowed to operate this product. If fault not solved after following troubleshooting table, please send this inverter back to local dealer or service center for maintenance.
7. **WARNING:** Because this inverter is non-isolated, only three types of PV modules are adaptable: single crystalline, poly crystalline with class A-rated and CIGS modules. To avoid any malfunction, do not connect any PV modules which likely with current leakage flow to the inverter. For example, grounded PV modules may cause current leakage flow to the inverter. When using CIGS modules, please be sure of NO grounding.
8. **CAUTION :** It's requested to use PV junction box with surge protection. Otherwise, it may cause damage on inverter.

2. INTRODUCTION

This is a multi function inverter, combining various function of inverter, solar charger and battery charger, supply uninterruptible electricity energy to loads. Its easy accessible comprehensive LCD touch screen display allowed user setting the various date according to user's requirements, such as battery charging current, AC/solar charger priority, and setting different input voltage based on different applications.

2.1 Features

1. Hybrid solar inverter(on/off grid inverter)
2. Output power factor PF=1.0
3. On grid with energy storage
4. Configurable AC/Solar Charger priority via LCD setting
5. Smart battery charger design for optimized battery performance
6. Compatible to mains voltage or generator power
7. Overload,Over temperature,Short circuit protection,Fault record,History record
8. External WIFI devices
9. The number of inverter for parallel operation can up to 9 units

2.2 Basic System Architecture

The following illustration shows basic application for this inverter/charger. It also includes following devices to have a complete running system:

Generator or AC.

PV modules

Consult with the integrator who provide you system about architectures as you request. This inverter can supply power to all kinds of appliances in home or office ,including motor - type appliances, such as tube light, fan, refrigerator, air-conditioner and so on.

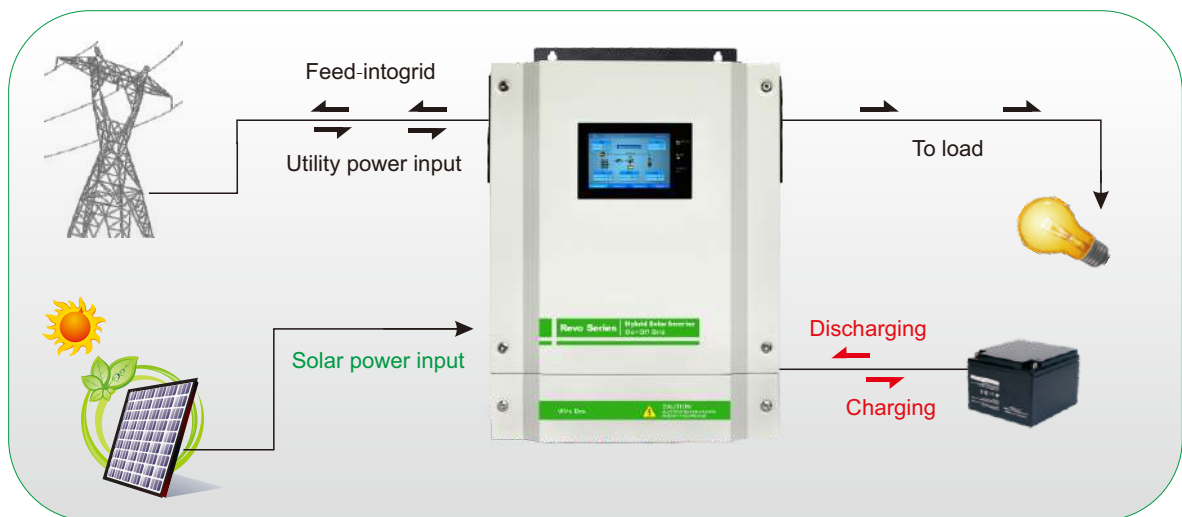
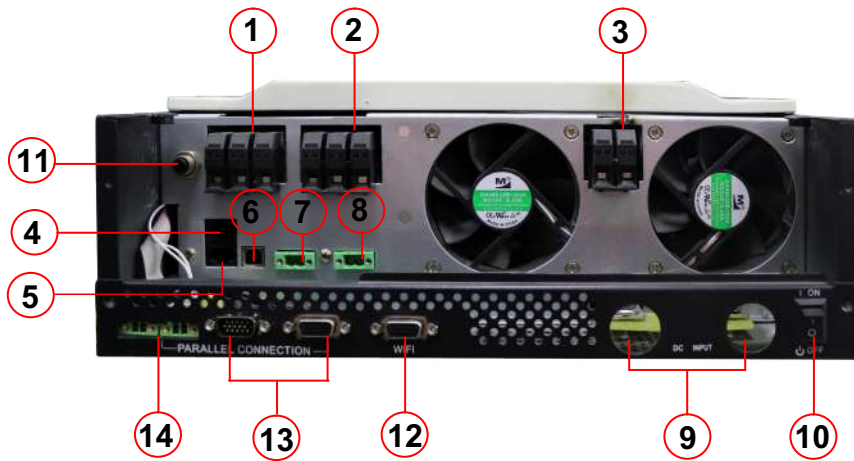

Figure 1 Hybrid Power System

2.3 Product Overview



- | | | |
|-------------------|--------------------------|---------------------------|
| 1. AC Input | 6. USB terminal | 11. circuit breaker |
| 2. AC Output | 7. CT interfaces | 12. WiFi interfaces |
| 3. PV Input | 8. Generator dry contact | 13. Parallel interfaces |
| 4. Can port | 9. DC Input | 14. Current sharing cable |
| 5. RS232 terminal | 10. ON/OFF switch | |

3. WIFI operation steps (optional)

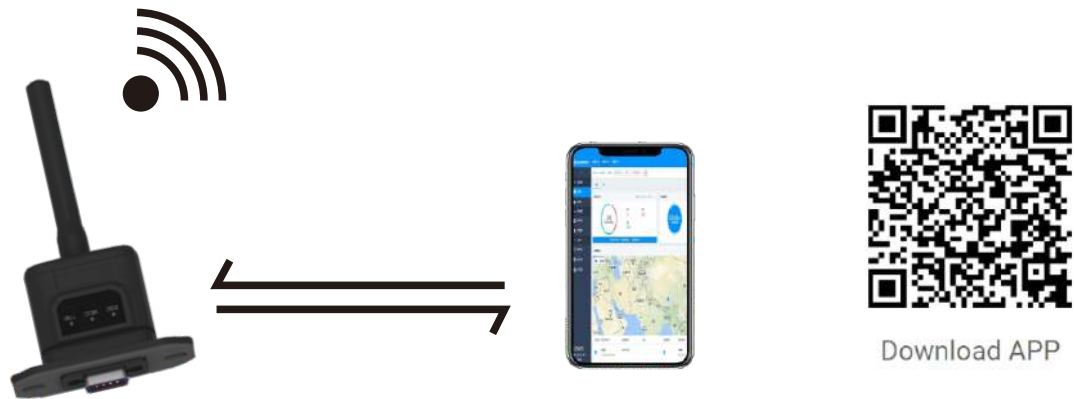

- 3.1. In the first enter the website at <https://home.solarmanpv.com> or scan QR code to download apps;
- 3.2. Connect the mobile phone to the family WIFI or the WIFI hotspot
- 3.3. Insert the WIFI data acquisition stick into the WIFI interface;
- 3.4. Open the application software "solarman";
- 3.5. After registering a new account, enter the user name and password;
- 3.6. Click "+" in the upper right corner, then click "add collector".
- 3.7. Point the phone at the QR code scan of the acquisition stick, or directly input the serial number of the acquisition stick.
- 3.8. After scanning the serial number, please enter into the WIFI setting of the mobile phone. Please find the WIFI serial number of the WIFI collection stick, and then enter the password of the collection stick;
- 3.9. After entering, you can check the equipment information.

4. INSTALLATION

4.1 Unpacking and Inspection

Before installation, please inspect the unit. Be sure that everything in the package is not damaged. The following items inside of package would be received.

The inverter x1
User manual x 1
Communication cable x 1

4.2 Preparation

Please remove the two screws on the back cover of the device before opening it.

4.3 Installation sites selection

Consider the below points before selecting where to install:

1. Do not mount the inverter on the surface of flammable construction materials.
2. Mount on the surface of solid material.
3. Install this inverter at a visible place in order to allow the LCD display to be read at all times.
4. For proper air circulation and heat dissipation, make sure there is 20 cm distance from the two sides, 50 cm distance from bottom of the unit.
5. The ambient temperature should be between 0°C and 55°C to ensure optimal operation.
6. The recommended installation position is to be adhered to the wall vertically.
7. Be sure to keep other objects and surfaces as shown in the diagram to guarantee sufficient heat dissipation and to have enough space for collecting wires.

Suitable for mounting on concrete or other non-combustible surface only

4.4 Battery Connection

CAUTION: For safety operation and regulation compliance, it's requested to adopt a separate DC over-current protector or disconnect device between battery and inverter. It may not be necessary to have a disconnect device in some applications, however, it's still need to adopt over-current protection device. Please refer to typical amperage in below table as required fuse or breaker size.

WARNING! All wiring must be performed by a qualified personnel.

WARNING! It's very important for system safety and efficient operation to use appropriate cable for battery connection. To reduce risk of injury, please use the proper cable as below.

24VDC battery connection diagram

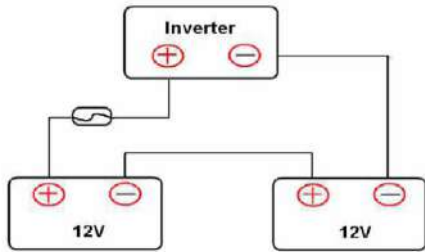

48VDC battery connection diagram

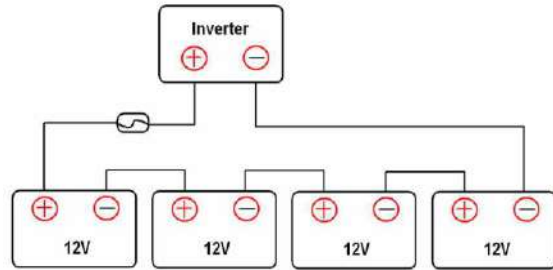

CAUTION! Before making the final DC connection or closing DC breaker/disconnector, be sure positive (+) must be connected to positive (+) and negative (-) must be connected to negative (-).

4.5 AC Input/Output Connection

CAUTION! Before connecting to AC input power source, please install a separate AC breaker between inverter and AC input power source. This will ensure the inverter can be securely disconnected during maintenance and fully protected from over current of AC input. The recommended spec of AC breaker is 32A for 3KVA and 50A for 5.5KVA. There are two terminal blocks with “IN” and “OUT” markings. Please do NOT connect input and output connectors wrong.

WARNING! All wiring must be performed by a qualified personnel. It's very important for system safety and efficient operation to use appropriate cable for AC input connection. To reduce risk of injury, please use the proper recommended cable size as below.

Model	Gauge	Cable (mm ²)	Torque Value
3KVA /3.2KVA	12 AWG	4	1.2 Nm
5.5KVA	10 AWG	6	1.2 Nm

CAUTION! Please install the CT in the direction of the CT in the picture as below .Wrong direction, CT will not work properly .

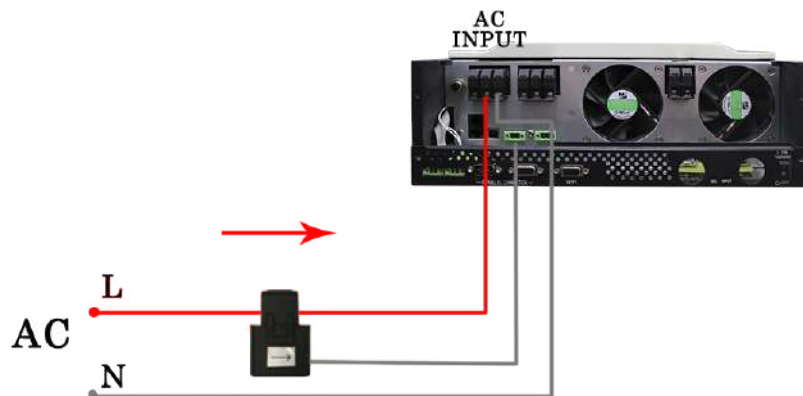

4.6 PV Connection

CAUTION: Before connecting to PV modules, please install separately a DC circuit breaker between inverter and PV modules.

WARNING: It's very important for system safety and efficient operation to use appropriate cable for PV module connection .To reduce risk of injury ,please use the proper cable size as below.

Model	Wire Size	Cable (mm ²)	Torque value(max)
3 - 5.5KVA	12AWG	4	1.2 Nm

WARNING: Because this inverter is non-isolated, only three types of PV modules are acceptable : single-crystalline, poly crystalline with class A-rated and CIGS modules .To avoid any malfunction, do not connect any PV modules with possible current leakage to the inverter. For example, grounded PV modules will cause current leakage to the inverter. When using CIGS modules, please be sure NO grounding.

CAUTION: It's requested to use PV junction box with surge protection. Otherwise, it will cause damage on inverter when lightning occurs on PV modules.

PV Module Selection:

When selecting proper PV modules, please be sure to consider below parameters:

1.Open circuit Voltage (Voc) of PV modules not exceeds max. PV array open circuit voltage of inverter.

2.Open circuit Voltage (Voc) of PV modules should be higher than min. battery voltage.

INVERTER MODEL	3 - 5.5KVA
Max. PV Array Open Circuit Voltage	450Vdc
PV Array MPPT Voltage Range	120Vdc~450Vdc

Application Example:

Solar Panel Spec. 250Wp Vmp: 30.1Vdc Imp: 8.3A Voc: 37.7Vdc Isc: 8.4A	SOLAR INPUT	Qty of panels	Total input power
	(Min in serial: 6 pcs, max. in serial: 12 pcs)		
	6 pcs in serial	6 pcs	1500W
	9 pcs in serial	9 pcs	2250W
	12 pcs in serial	12 pcs	3000W
	9 pieces in serial and 2 sets in parallel	18 pcs	4500W

PV Module Wire Connection

Please follow below steps to implement PV module connection:

1. Remove insulation sleeve 10 mm for positive and negative conductors.
2. Suggest to put bootlace ferrules on the end of positive and negative wires with a proper crimping tool.
3. Fix PV wire cover to the inverter with supplied screws as shown in below chart.

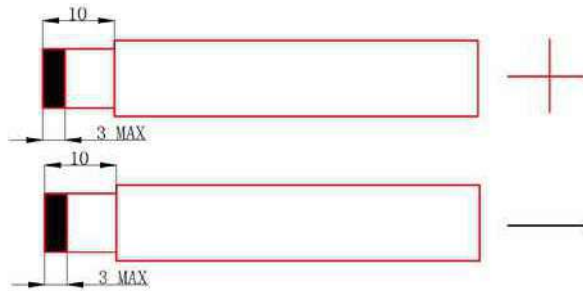

4.7 Final Assembly

After connecting all wires, please put bottom cover back by screwing screws.

4.8 Communication Connection

Please use supplied communication cable to connect inverter and PC, follow the instructions on the screen to install the monitoring software. For the detailed software operation, please check user manual.

5. OPERATION

5.1 Power ON/OFF

Once the unit has been properly installed and the batteries are connected well, simply press On/Off switch(located on the button of the case) to turn on the unit.

5.2 Operation and Display Panel



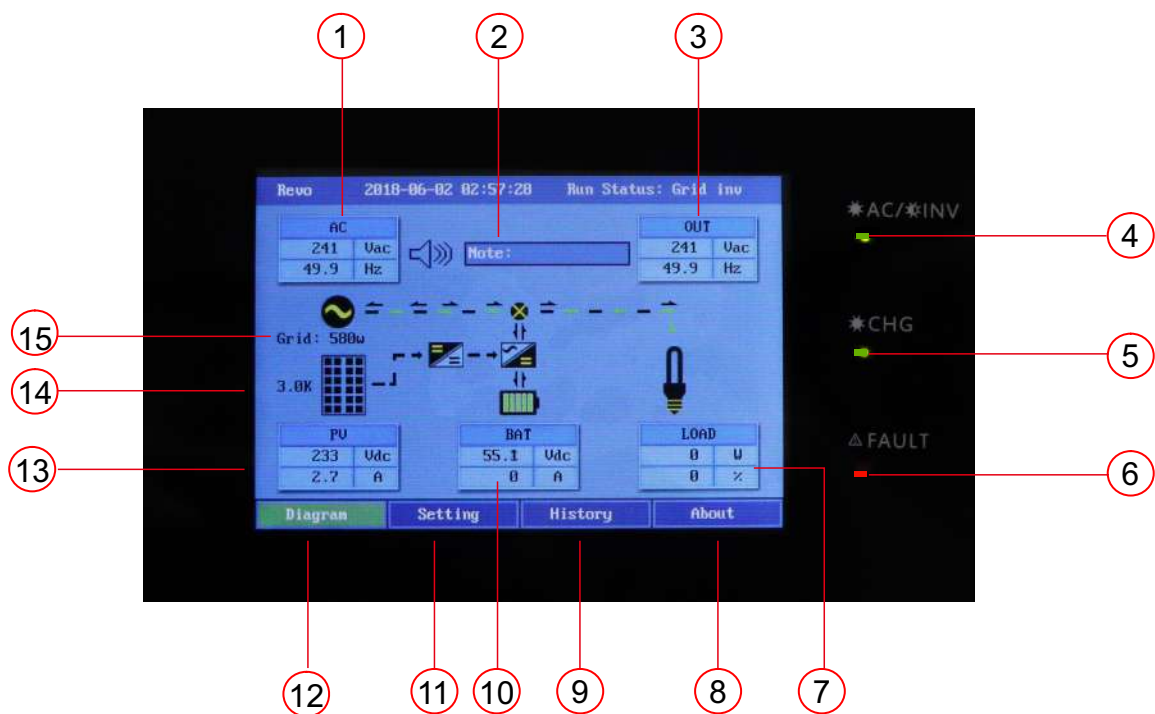

The operation and display panel, shown in below chart, is on the front panel of the inverter. It includes three indicators, four function keys and a LCD display, indicating the operating status and input/output power information.



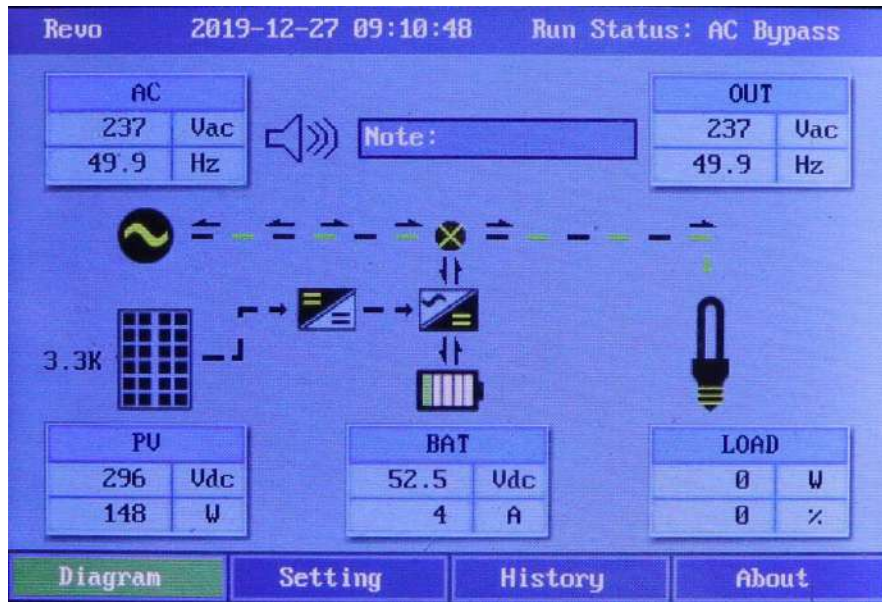

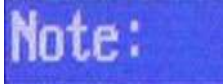
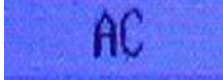
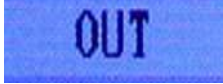
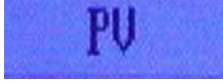

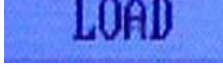

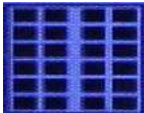

1. AC Input information
2. Operation information
3. AC Output information
4. AC/INV indicator
5. Charging indicator
6. Fault indicator
7. Load information
8. About button
9. History button
10. Battery information
11. Setting button
12. Diagram button
13. PV input information
14. PV capacity
15. Grid / CT power

5.3 LCD Display Icons

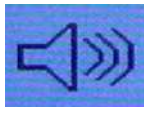

Icon	Description
	Product model and operation time
	Operation information include fault and warning code
	Input voltage and frequency information
	Output voltage and frequency information
	PV voltage and power information
	Battery voltage and current information
	Load power and percent information
	Indicates unit connects to the mains

	Indicates unit connects to the PV panel
	Indicates the DC/DC inverter circuit is working
	Indicates the AC charger circuit is working
	Indicates battery level
	Indicates the load
Function Button	Description
	Mute button
	Work state diagram
	The setting button include language, working mode, input, output, battery, charge, PV, parallel, date and time, Grid, peak valley, and other function settings
	This button includes generation, event, help
	This button includes LCD, inverter, MPPT version, inverter model

5.4 LCD Setting

After press function button, the unit will enter setting mode. Set password:1155

Button	Function	Illustrate
Diagram	Main Display Interface	Return to the default display screen
Set up	Language	<p>Chinese: Chinese display</p> <p>English: English Display</p>
	Working mode	<p>AC: (default) AC will provide power to the loads as the first priority, solar charging the battery. When solar energy is insufficient, AC and solar energy charge the battery at the same time. When AC is unavailable, it will be powered by solar energy or batteries.</p>
		<p>Solar: Solar energy provides power to the loads as the first priority. When the solar energy is sufficient, the extra energy will charges the battery. When solar energy is insufficient for load, batteries and solar will supply power the loads at the same time. When solar energy and batteries are insufficient or solar energy is unavailable, AC power to the loads and charge the battery at the same time.</p>
		<p>Battery: Battery provides power to the loads as the first priority. AC provides power to the loads when battery voltage drop to low-level warning voltage or setting point, and the AC power will charge the battery. When the battery is fully charged, battery provides power to the loads again.</p>
		<p>Solar + AC: Solar energy provides power to the loads as the first priority. If solar energy is not sufficient to power all loads, AC energy will supply power to the loads at the same time.</p>

Set up	Input	<p>AC Width Range: (Default) 120–280Vac</p> <p>AC narrow range: 170–280Vac</p>
	Output	<p>Output Voltage: (Default) 230Vac、 220Vac 、 240Vac</p> <p>Output frequency: (Default)50Hz 、 60Hz</p>
	Battery	<p>Battery Type: (Default) Lead–acid Battery, Lithium Battery Communication, No Battery, Customization</p>
		<p>Low-voltage alarm: 24V mode: (Default 22.0 Vdc) setting range:18V to 25V 48V mode: (Default 44.0Vdc) setting range: 36V to 50V</p> <p>Low Voltage Shutdown: 24V mode: (Default 21.0 Vdc) setting range:18V to 25V 48V mode: (Default 42.0Vdc) setting range: 36V to 50V setting increase or decrease of 0.1V.</p>
		<p>Bulk charging voltage: 24V mode: (Default 28.0 Vdc) setting range:24V to 30V 48V mode: (Default 56.0Vdc) setting range: 48V to 60V</p> <p>Floating charge voltage: 24V mode: (Default 27.0 Vdc) setting range:24V to 30V 48V mode: (Default 54.0Vdc) setting range: 48V to 60V setting increase or decrease of 0.1V.</p> <p>Please note: if you need set this, please select user–defined first in battery working mode.</p>
	Charge current	<p>Charge: (default 30A) setting range is 10A to 60A, the increment or decrement is 10A per click</p> <p>Discharge:</p>
PV	<p>PV CAP: (Default 3k) According to the actual capacity of the solar plate, users fill in and set the rang of 1kva-8kva, the increment or decrement is 0.1k per click</p>	

Set up	Parallel setting	<p>Sing phase: include “parallel” and “ID” setting</p> <p>Three phase: include “parallel” and “A/B/C” three phase setting</p>
	Date &Time setting	You can set the local date and time in your country
	On grid choose	Select “OnGrid” in Grid setting; when in OnGrid mode Solar will power loads first , then extra power feed back to utility ; when Solar power is not enough, the utility will assist it to power loads.
	CT function choose	<p>Choose the AC + PV mode first, then choose the “Out Side CT ” . (in output side, when your loads power is big, PV will give more power to supplement it, but the biggest power it can supplied is PV output rate power.)</p> <p>Please note: The direction of the CT must be right. (CT is connected in input side)</p>
	Peak and Valley	Can set the discharge time when peak or valley
	Others	Factory Default setting
History setting	Generated energy record	Generated energy diagram display for per Day/Month/Year
	Faulty data record	History record for faulty date or others
	Help	Some solutions to failures and warnings
About	Version data	Version data display for LCD/inverter control board/MPPT program and machine model

5.5 Parallel function operation instructions

(Maximum of nine parallel machines)

Single phase parallel :

1. Connecting the parallel communication line and power cable as shown below

Warning : All inverters must share the same battery pack when paralleling.

2. Set the parameters of each inverter separately (working mode, single-phase parallel function, parallel ID).

Warning : When working in parallel, the working mode of each inverter must be the same working mode, and the ID address of each inverter cannot be repeated.

3. After setting the parameters, turn on each inverter in turn.

Two inverters parallel:

Power Connection:

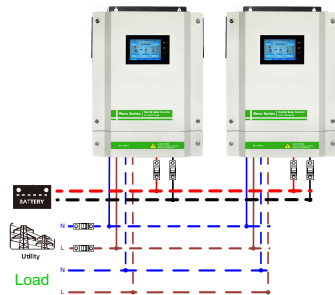

Communication Connection :

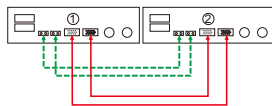

Three inverters parallel:

Power Connection:

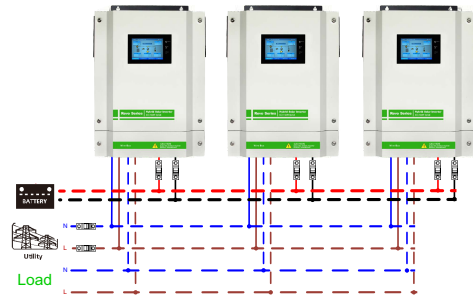

Communication Connection :

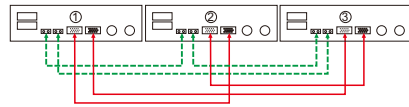

Six inverters parallel:

Power Connection:

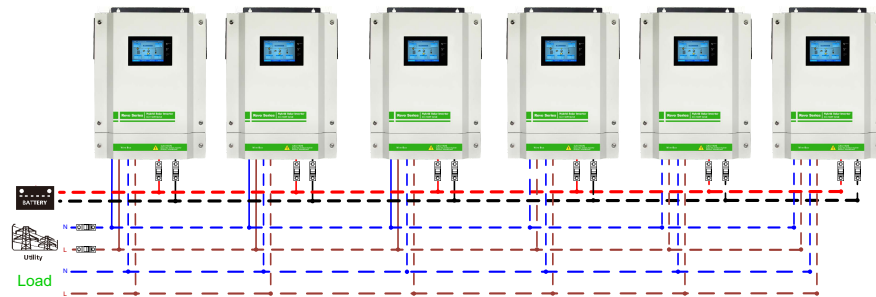

Communication Connection :

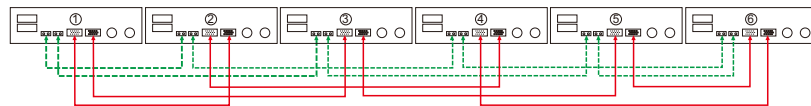

Nine inverters parallel:

Power Connection:

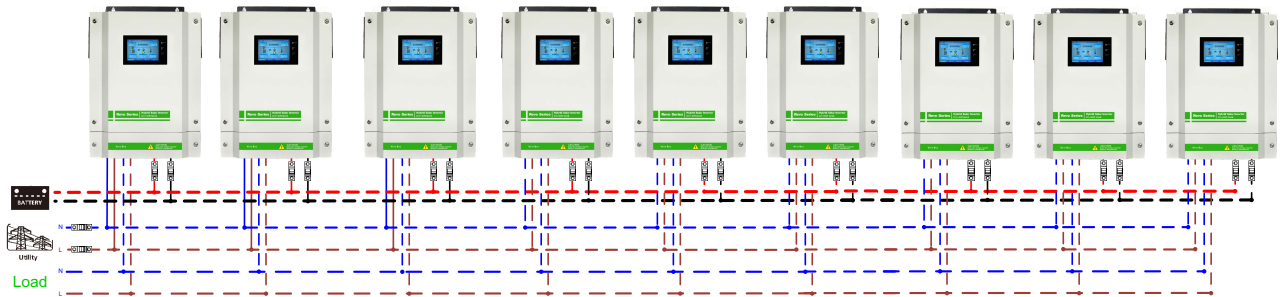

Communication Connection :

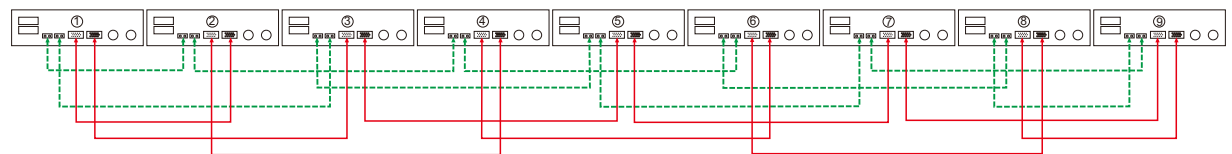

Three-phase parallel :

1. Connecting the parallel communication line and power cable as shown below

Warning : All inverters must share the same battery pack when paralleling

2. Set the parameters of each inverter independently (working mode, single-phase parallel function, parallel ID address, three-phase parallel function and set A/B/C phase sequence).

Warning : When working in parallel, the working mode of each inverter must be the same working mode. And the ID address of each inverter cannot be repeated.

3. After setting the parameters, first turn on the A phase inverter and then turn on each inverters in turn.

One inverter in each phase:

Power connection:

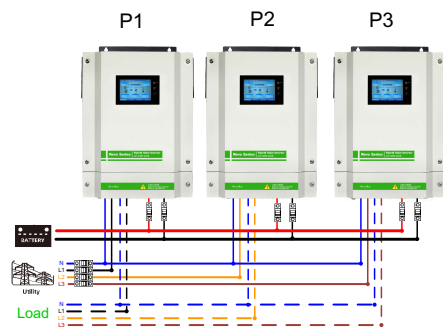

Communication connection:

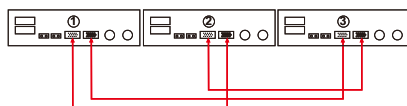

Two inverter in each phase:
Power connection:

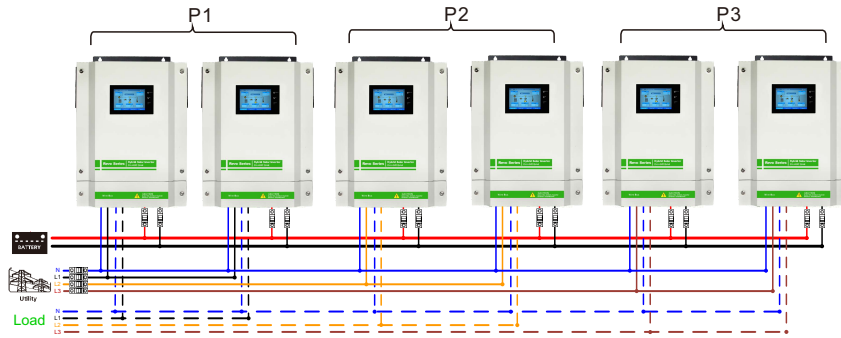

Communication connection:

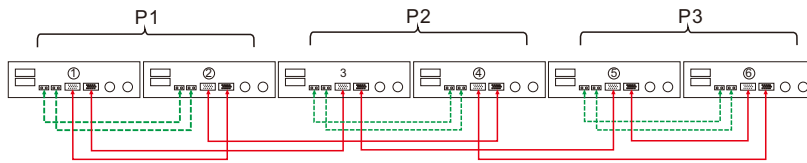

Three inverter in each phase:
Power connection:

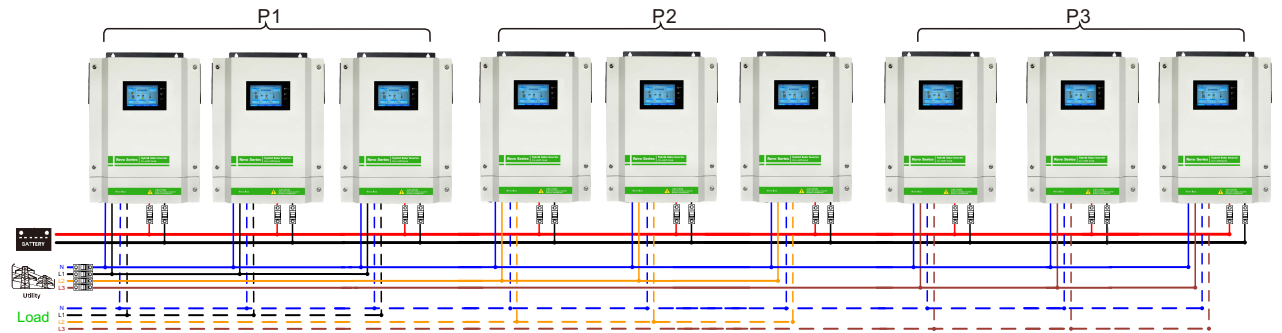

Communication connection:

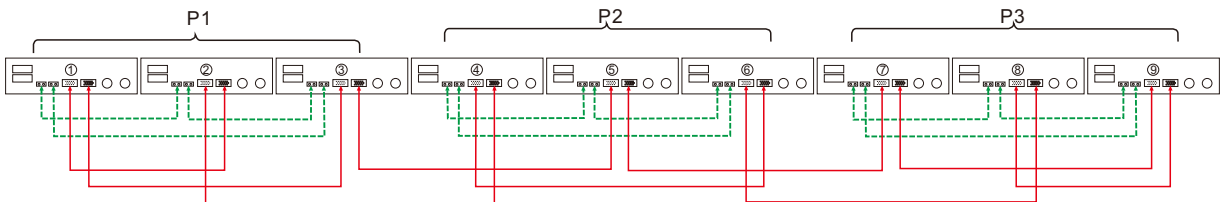

5.6 Fault Reference Code

Fault code	Fault event
01	Bus voltage is too high
02	Inverter voltage is too high
03	Inverter voltage is too low
04	Bus soft start failure
05	Overload fault
06	Output short circuited
07	Battery voltage is too low
08	Inverter soft start failure
09	Bus voltage is too low
10	Parallel fault
11	Over temperature
12	Battery voltage is too high
21	PV voltage is too low
22	PV voltage is too high
23	PV is over current
24	PV over temperature
25	PV overload
26	PV boost fault

5.7 Warning Indicator

Warning code	Warning Event
01	Battery voltage is too low
02	Input voltage is too low
03	Input voltage is too high
04	Overload
05	Over temperature
06	Fan is locked when inverter is on
07	Battery low voltage shutdown
08	Battery voltage is too high

6.TROUBLE SHOOTING

Problem	LCD/LED/Buzzer	Possible cause	What to do
Unit shuts down automatically during start up process	LCD/LED and buzzer will be active then complete off	The battery voltage is too low	1.Re-charge battery. 2. Replace battery
No response after power on	No indication	1.The battery voltage is too low. 2. Internal fuse tripped	1. Contact repair center for replacing the fuse. 2. Re-charge battery. 3. Replace battery
Mains exist but the unit works in battery mode	Input voltage is displayed as '0' on the LCD and green LED is flashing	Input protector is triggered	Check if AC breaker is turned on and AC wiring is connected well.

	LED is flashing	Insufficient quality of AC power	1. Check if AC wires are too thin and/or too long. 2. Check if generator (if applied) is working well or if input voltage range setting is correct. (UPS Appliance)Change output source
When the unit is turned on, internal relay is switched on and off repeatedly	LCD display and LED flashing	Battery is disconnected	Check if battery wires are connected well
Buzzer beeps continuously and red LED is on	warning code 06	Fan fault	Replace the fan
	warning code 05	Internal temperature of inverter component is over 100°C	Check whether the environment around the equipment well ventilated
	warning code 08	The battery voltage is too high	Check if spec and quantity of batteries are meet requirements
		Battery is over-charged	Return to repair center
	Fault code 10	Parallel fault	Please check if the connection between the inverters is loose
	Fault code 06	Output short circuited	Check if wiring is connected well and remove abnormal load
	warning code 05	Overload error , the inverter is overload 100% and overload time reaches the upper limit	Reduce the connected load by switching off some equipment

	Fault code 22	If PV input voltage is higher than specification, the output power will be derated. At this time, if connected loads is higher than derated output power, it will cause overload	Reduce the number of PV modules in series or the connected load
	Fault code 02/03	Output abnormal (Inverter voltage below than 190Vac or is higher than 260Vac)	1. Reduce the connected load 2. Return to repair center
	Fault code 01/04/06/08	Internal components failed	Return to repair center
	Fault code 23	Over current or surge	Remove abnormal load or check PV input
	Fault code 01	Bus voltage is too high	Restart the unit if the error happens again please return to repair center
	Fault code 09	Bus voltage is too low	
	Fault code 02/03	Output voltage is unbalanced	
	Fault code 11	Internal temperature of inverter component is over 100°C	Check whether the environment around the equipment well ventilated
	Fault code 12	The battery voltage is too high	Check if spec and quantity of batteries are meet requirements
		Battery is over-charged	Return to repair center

7. SPECIFICATIONS

Table 1 Solar Mode Specifications

MODEL	3KVA 24VDC	3.2KVA 48VDC	5.5KVA 48VDC
Rated output power	3KVA/3KW	3.2KVA/3.2KW	5.5KVA/5.5KW
PV Max power	5000W		
PV operating voltage range	120-450VDC		
PV normal operating voltage	280-360VDC		
Normal output voltage	230VAC		
Output voltage range	230 ± 5% VAC		
Normal output current	13A	14A	24A
Power factor	1.0		
Efficiency(DC/AC)	up to 93%		
Frequency	50/60Hz		
Overload protection	MPPT will close immediately as long as the input power is greater than the maximum output power		
PV Max input current	20A		

Table 2 Line Mode Specifications

Input Voltage Waveform	Pure sine wave (utility or generator)
Normal Input Voltage	230VAC
Low Loss Voltage	120VAC \pm 7V (wide range) 170VAC \pm 7V(narrow range)
Low Loss Return Voltage	130VAC \pm 7V (wide range) 180VAC \pm 7V(narrow range)
High Loss Voltage	280VAC \pm 7V
High Loss Return Voltage	270VAC \pm 7V
Max AC Input Voltage	300VAC
Normal Input Frequency	50Hz / 60Hz (Auto detection)
Low loss Frequency	40 \pm 1Hz
Low loss Return Frequency	42 \pm 1Hz
High loss Frequency	70 \pm 1Hz
High loss Return Frequency	69 \pm 1Hz
Output short circuit protection	Circuit Breaker
Efficiency (Line Mode)	>95% (Rated R load, battery full charged)
Communication	USB or RS232 or WIFI
Humidity	0-90% RH(No-condensing)
Operation temperature	0-50°C

Table 3 Charge Mode Specifications

INVERTER MODEL	3KVA	3.2KVA	5.5KVA
Charging Algorithm	3-Step		
Charging Mode			
Charging Current	10/20/30/40/50/60Amp (@ $V_{IP}=230V_{ac}$)		
Bulk Charging Voltage	24.0-30.0vdc (Default:28 vdc)	48.0-60.0vdc (Default:56 vdc)	
Floating Charging Voltage	24.0-30.0vdc (Default:27vdc)	48.0-60.0vdc (Default:54vdc)	
Charging Curve	<p>The graph plots Battery Voltage (per cell) on the left y-axis and Charging Current (%) on the right y-axis against Time on the x-axis. The voltage curve (black line) rises linearly in the Bulk stage, remains constant in the Absorption stage, and then slightly drops and remains constant in the Maintenance stage. The current curve (red line) remains constant at 100% in the Bulk stage, then decays exponentially in the Absorption stage, and finally reaches a low, constant level in the Maintenance stage. Key voltage points are marked as 2.43Vdc (2.35Vdc) and 2.25Vdc. Time intervals T0 and T1 are indicated, with a note that T = 10 * T0, minimum 10 mins, maximum 10 hrs.</p>		
Max. charging current (Solar+AC)	80A		
Over-charging voltage	30vdc	60vdc	

Table 4 Inverter Mode Specifications

Normal DC voltage	24V	48V
Waveform	Pure sine wave	
Output Voltage Regulation	230VAC±5%	
Output Frequency	50/60Hz±1Hz	
Peak Efficiency	≥90%	
Power factor	1.0	
Overload Protection	20s@101%~120% load , 10s@121%~150% load, 3-6s@≥150% load	
Transfer time	10ms typical (UPS); 20ms typical (Appliances)	
Protection features	Low voltage protection; High voltage protection Overload protection ; Over-temperature protection Short circuit protection; Over-charge protection; Battery reverse protection	
Cold start voltage	23.0VDC	46.0VDC
Low voltage alarm(optional)	18.0-25.0VDC	36.0-50.0VDC
Low voltage alarm recovery	22.0VDC	44.0VDC
Low voltage shutdown(optional)	18.0-25.0VDC	36.0-50.0VDC
High voltage alarm recovery	30.0VDC	60.0VDC
Dimension(WxDxH)mm	345x476x133.2	
Net Weight (KG)	11.75	11.9
Gross Weight (KG)	12.75	13.1

614.C0400-03