

# User Manual

## SOLAR INVERTER **5 KW**

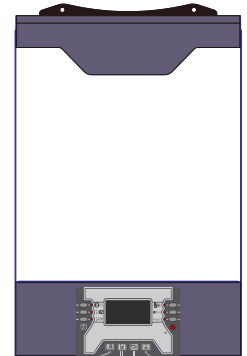

# Table Of Contents

<b>ABOUT THIS MANUAL</b> .....	1
Purpose .....	1
Scope .....	1
<b>SAFETY INSTRUCTIONS</b> .....	1
<b>INTRODUCTION</b> .....	2
Product Overview .....	3
<b>INSTALLATION</b> .....	4
Unpacking and Inspection.....	4
Preparation .....	4
Mounting the Unit .....	4
Battery Connection .....	5
AC Input/Output Connection .....	6
PV Connection .....	7
Final Assembly .....	8
Communication Connection .....	9
Dry Contact Signal .....	9
<b>OPERATION</b> .....	10
Power ON/OFF .....	10
Operation and Display Panel .....	10
LCD Display Icons .....	11
LCD Setting .....	13
Display Setting .....	25
Operating Mode Description .....	30
Faults Reference Code .....	33
Warning Indicator .....	34
<b>BATTERY EQUALIZATION</b> .....	35
<b>SPECIFICATIONS</b> .....	37
Table 1 Line Mode Specifications .....	37
Table 2 Inverter Mode Specifications .....	38
Table 3 Charge Mode Specifications .....	39
Table 4 General Specifications .....	40
<b>TROUBLE SHOOTING</b> .....	41
Appendix I: Parallel function.....	42
Appendix II: Approximate Back-up Time Table.....	60

## ABOUT THIS MANUAL

### Purpose

This manual describes the assembly, installation, operation and troubleshooting of this unit. Please read this manual carefully before installations and operations. Keep this manual for future reference.

### Scope

This manual provides safety and installation guidelines as well as information on tools and wiring.

## SAFETY INSTRUCTIONS



**WARNING: This chapter contains important safety and operating instructions. Read and keep this manual for future reference.**

1. Before using the unit, read all instructions and cautionary markings on the unit, the batteries and all appropriate sections of this manual.
2. **CAUTION** --To reduce risk of injury, charge only deep-cycle lead acid type rechargeable batteries. Other types of batteries may burst, causing personal injury and damage.
3. Do not disassemble the unit. Take it to a qualified service center when service or repair is required. Incorrect re-assembly may result in a risk of electric shock or fire.
4. To reduce risk of electric shock, disconnect all wirings before attempting any maintenance or cleaning. Turning off the unit will not reduce this risk.
5. **CAUTION** – Only qualified personnel can install this device with battery.
6. **NEVER** charge a frozen battery.
7. For optimum operation of this inverter/charger, please follow required spec to select appropriate cable size. It's very important to correctly operate this inverter/charger.
8. Be very cautious when working with metal tools on or around batteries. A potential risk exists to drop a tool to spark or short circuit batteries or other electrical parts and could cause an explosion.
9. Please strictly follow installation procedure when you want to disconnect AC or DC terminals. Please refer to INSTALLATION section of this manual for the details.
10. Fuses are provided as over-current protection for the battery supply.
11. **GROUNDING INSTRUCTIONS** -This inverter/charger should be connected to a permanent grounded wiring system. Be sure to comply with local requirements and regulation to install this inverter.
12. **NEVER** cause AC output and DC input short circuited. Do NOT connect to the mains when DC input short circuits.
13. **Warning!!** Only qualified service persons are able to service this device. If errors still persist after following troubleshooting table, please send this inverter/charger back to local dealer or service center for maintenance.

# INTRODUCTION

This hybrid PV inverter can provide power to connected loads by utilizing PV power, utility power and battery power.

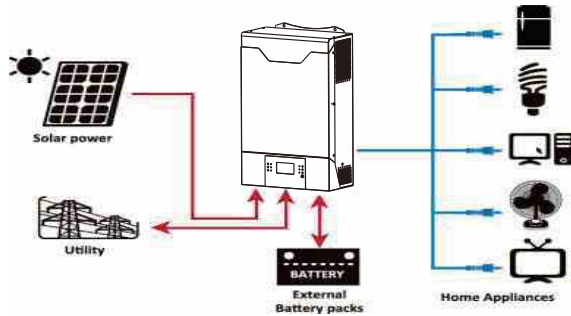
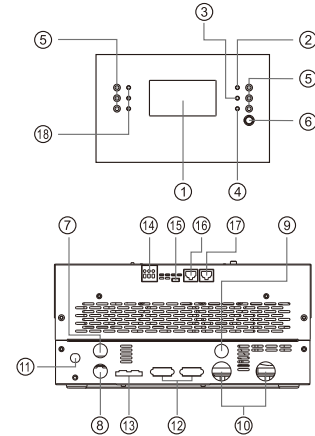
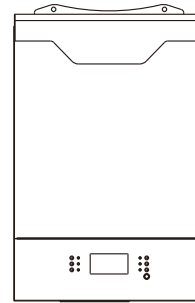

Figure 1 Basic hybrid PV System Overview

Depending on different power situations, this hybrid inverter is designed to generate continuous power from PV solar modules (solar panels), battery, and the utility. When MPP input voltage of PV modules is within acceptable range (see specification for the details), this inverter is able to generate power to feed the grid (utility) and charge battery. Galvanic isolation designed between PV/DC and AC output, so that user could connect any type of PV array to this Hybrid inverter. See Figure 1 for a simple diagram of a typical solar system with this hybrid inverter.

# Product Overview



**NOTE:** For parallel model installation and operation, please check separate parallel installation guide for the details.

- |                        |  |
|------------------------|--|
| 1. LCD display         | 7. AC input  |
| 2. Status indicator    | 8. AC output   |
| 3. Charging indicator  | 9. PV input  |
| 4. Fault indicator     | 10. Battery input  |
| 5. Function buttons    | 11. Circuit breaker  |
| 6. Power on/off switch | 12. Parallel communication cable (only for parallel model) |

- 13. Current sharing cable (only for parallel model)
- 14. Dry contact
- 15. USB communication port
- 16. BMS communication port: CAN, RS-485 or RS-232
- 17. RS-232 communication port
- 18. LED indicators for USB function setting / Output source priority timer / Charger source priority setting

# INSTALLATION

## Unpacking and Inspection

Before installation, please inspect the unit. Be sure that nothing inside the package is damaged. You should have received the following items inside of package:



## Preparation

Before connecting all wirings, please take off bottom cover by removing two screws as shown below.

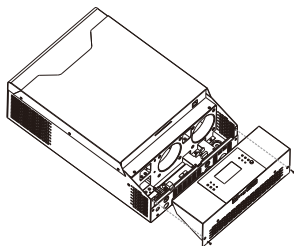

## Mounting the Unit

Consider the following points before selecting where to install:

- Do not mount the inverter on flammable construction materials.
- Mount on a solid surface
- Install this inverter at eye level in order to allow the LCD display to be read at all times.
- The ambient temperature should be between 0°C and 55°C to ensure optimal operation.
- The recommended installation position is to be adhered to the wall vertically.
- Be sure to keep other objects and surfaces as shown in the right diagram to guarantee sufficient heat dissipation and to have enough space for removing wires.

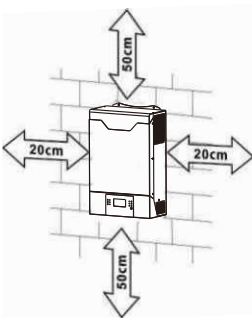

**! SUITABLE FOR MOUNTING ON CONCRETE OR OTHER NON-COMBUSTIBLE SURFACE ONLY.**

Install the unit by screwing three screws. It's recommended to use M4 or M5 screws.

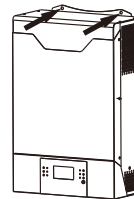

## Battery Connection

**CAUTION:** For safety operation and regulation compliance, it's requested to install a separate DC over-current protector or disconnect device between battery and inverter. It may not be requested to have a disconnect device in some applications, however, it's still requested to have over-current protection installed. Please refer to typical amperage in below table as required fuse or breaker size.

**Ring terminal:**

**WARNING!** All wiring must be performed by a qualified personnel.

**WARNING!** It's very important for system safety and efficient operation to use appropriate cable for battery connection. To reduce risk of injury, please use the proper recommended cable and terminal size as below.

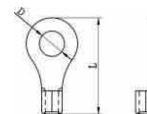

**Recommended battery cable and terminal size:**

Model	Typical Amperage	Battery Capacity	Wire Size	Ring Terminal		Torque Value
				Cable mm <sup>2</sup>	Dimensions D (mm) L (mm)	
5KW	135A	200AH	2*4AWG	44	6.4 49.7	2~3 Nm

Please follow below steps to implement battery connection:

- Assemble battery ring terminal based on recommended battery cable and terminal size.
- Insert the ring terminal of battery cable flatly into battery connector of inverter and make sure the nuts are tightened with torque of 2-3 Nm. Make sure polarity at both the battery and the inverter/charge is correctly connected and ring terminals are tightly screwed to the battery terminals.

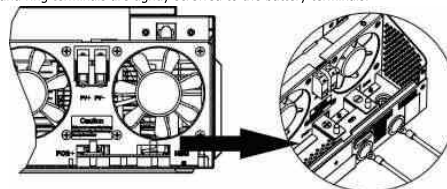

**! WARNING: Shock Hazard**

Installation must be performed with care due to high battery voltage in series.

 **CAUTION!!** Do not place anything between the flat part of the inverter terminal and the ring terminal. Otherwise, overheating may occur.

**CAUTION!!** Do not apply anti-oxidant substance on the terminals before terminals are connected tightly.

**CAUTION!!** Before making the final DC connection or closing DC breaker/disconnector, be sure positive (+) must be connected to positive (+) and negative (-) must be connected to negative (-).

## AC Input/Output Connection

**CAUTION!!** Before connecting to AC input power source, please install a **separate** AC breaker between inverter and AC input power source. This will ensure the inverter can be securely disconnected during maintenance and fully protected from over current of AC input.

**CAUTION!!** There are two terminal blocks with "IN" and "OUT" markings. Please do NOT mis-connect input and output connectors.

**WARNING!** All wiring must be performed by a qualified personnel.

**WARNING!** It's very important for system safety and efficient operation to use appropriate cable for AC input connection. To reduce risk of injury, please use the proper recommended cable size as below.

**Suggested cable requirement for AC wires**

Model	Gauge	Torque Value
5KW	10 AWG	1.2~ 1.6 Nm

Please follow below steps to implement AC input/output connection:

1. Before making AC input/output connection, be sure to open DC protector or disconnector first.
2. Remove insulation sleeve 10mm for six conductors. And shorten phase L and neutral conductor N 3 mm.
3. Insert AC input wires according to polarities indicated on terminal block and tighten the terminal screws. Be sure to connect PE protective conductor (⊕) first.

 → **Ground (yellow-green)**

**L** → **LINE (brown or black)**

**N** → **Neutral (blue)**

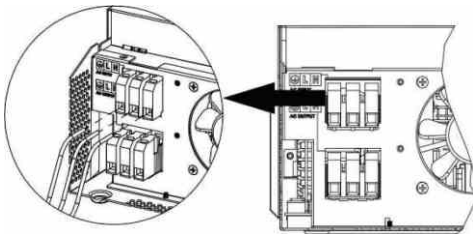

 **WARNING:**  
Be sure that AC power source is disconnected before attempting to hardwire it to the unit.

4. Then, insert AC output wires according to polarities indicated on terminal block and tighten terminal screws. Be sure to connect PE protective conductor (⊕) first.

 → **Ground (yellow-green)**

**L** → **LINE (brown or black)**

**N** → **Neutral (blue)**

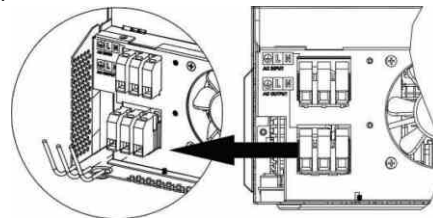

5. Make sure the wires are securely connected.

### CAUTION: Important

Be sure to connect AC wires with correct polarity. If L and N wires are connected reversely, it may cause utility short-circuited when these inverters are worked in parallel operation.

**CAUTION:** Appliances such as air conditioner are required at least 2~3 minutes to restart because it's required to have enough time to balance refrigerant gas inside of circuits. If a power shortage occurs and recovers in a short time, it will cause damage to your connected appliances. To prevent this kind of damage, please check manufacturer of air conditioner if it's equipped with time-delay function before installation. Otherwise, this inverter/charger will trig overload fault and cut off output to protect your appliance but sometimes it still causes internal damage to the air conditioner.

## PV Connection

**CAUTION:** Before connecting to PV modules, please install **separately** a DC circuit breaker between inverter and PV modules.

**WARNING!** All wiring must be performed by a qualified personnel.

**WARNING!** It's very important for system safety and efficient operation to use appropriate cable for PV module connection. To reduce risk of injury, please use the proper recommended cable size as below.

Model	Typical Amperage	Cable Size	Torque
5KW	18A	12AWG	1.2~1.6Nm

### PV Module Selection:

When selecting proper PV modules, please be sure to consider below parameters:

1. Open circuit Voltage (Voc) of PV modules not exceeds max. PV array open circuit voltage of inverter.
2. Open circuit Voltage (Voc) of PV modules should be higher than min. battery voltage.

Solar Charging Mode	
<b>INVERTER MODEL</b>	<b>5KW</b>
Max. PV Array Open Circuit Voltage	450 Vdc
PV Array MPPT Voltage Range	120~430Vdc
MPP Number	1

Please follow below steps to implement PV module connection:

1. Remove insulation sleeve 10 mm for positive and negative conductors.
2. Check correct polarity of connection cable from PV modules and PV input connectors. Then, connect positive pole (+) of connection cable to positive pole (+) of PV input connector. Connect negative pole (-) of connection cable to negative pole (-) of PV input connector.

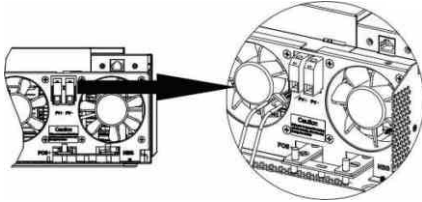

### Recommended PV module Configuration

PV Module Spec. (reference)	Total solar input power	Solar input	Q'ty of modules
- 250Wp	1500W	6 pieces in series	6 pcs
- Vmp: 30.7Vdc	2000W	8 pieces in series	8 pcs
- Imp: 8.15A	2750W	11 pieces in series	11 pcs
- Voc: 37.4Vdc	3000W	6 pieces in series 2 strings in parallel	12 pcs
- Isc: 8.63A	4000W	8 pieces in series 2 strings in parallel	16 pcs
- Cells: 60	5000W	10 pieces in series 2 strings in parallel	20 pcs

### Final Assembly

After connecting all wirings, please put bottom cover back by screwing two screws as shown below.

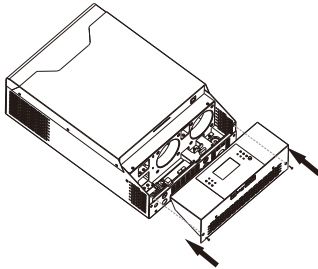

## Communication Connection

### Serial Connection

Please use supplied communication cable to connect to inverter and PC. Insert bundled CD into a computer and follow on-screen instruction to install the monitoring software. For the detailed software operation, please check user manual of software inside of CD.

### Wifi Connection

This series is built in Wifi technology. It allows wireless communication up to 6~7m in an open space.



### Dry Contact Signal

There is one dry contact (3A/250VAC) available on the rear panel. It could be used to deliver signal to external device when battery voltage reaches warning level.

Unit Status	Condition	Dry contact port: 		
		NC & C	NO & C	
Power Off	Unit is off and no output is powered.	Close	Open	
Power On	Output is powered from Utility.	Close	Open	
	Output is powered from Battery or Solar. Program 01 is set as SUB	Battery voltage < Low DC warning voltage	Open	Close
		Battery voltage > Setting value in Program 21 or battery charging reaches floating stage	Close	Open
	Program 01 is set as SBU	Battery voltage < Setting value in Program 20	Open	Close
		Battery voltage > Setting value in Program 21 or battery charging reaches floating stage	Close	Open

# OPERATION

## Power ON/OFF

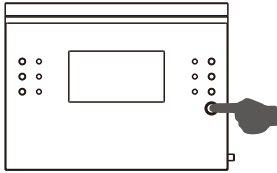

Once the unit has been properly installed and the batteries are connected well, simply press On/Off switch (located on the display panel) to turn on the unit.

## Operation and Display Panel

The operation and display panel, shown in below chart, is on the front panel of the inverter. It includes six indicators, six function keys, on/off switch and a LCD display, indicating the operating status and input/output power information.

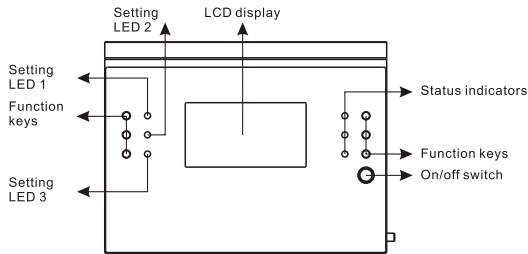

## Indicators

LED Indicator	Color	Solid/Flashing	Messages	
<b>Setting LED 1</b>	Green	Solid On	Output powered by utility	
<b>Setting LED 2</b>	Green	Solid On	Output powered by PV	
<b>Setting LED 3</b>	Green	Solid On	Output powered by battery	
<b>Status indicators</b>	<b>AC</b>	Green	Solid On	Output is available in bypass mode
	<b>INV</b>	Green	Flashing	Output is powered by battery in inverter mode
	<b>CHG</b>	Green	Solid On	Battery is fully charged
		Green	Flashing	Battery is charging.
	<b>FAULT</b>	Red	Solid On	Fault mode
Flashing			Warning mode	

## Function Keys

Function Key	Description
	ESC Exit the setting
	USB function setting Select USB OTG functions
	Timer setting for the Output source priority Setup the timer for prioritizing the output source
	Timer setting for the Charger source priority Setup the timer for prioritizing the charger source
	Up To last selection
	Down To next selection
	Enter To confirm/enter the selection in setting mode

## LCD Display Icons

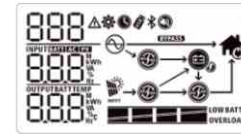

Icon	Function description	
<b>Input Source Information</b>		
	Indicates the AC input.	
	Indicates the PV input	
	Indicate input voltage, input frequency, PV voltage, charger current, charger power, battery voltage.	
<b>Configuration Program and Fault Information</b>		
	Indicates the setting programs.	
	Indicates the warning and fault codes.	
<b>Output Information</b>		
	Indicate output voltage, output frequency, load percent, load in VA, load in Watt and discharging current.	
<b>Battery Information</b>		
	Indicates battery level by 0-24%, 25-49%, 50-74% and 75-100% in battery mode and charging status in line mode.	
In AC mode, it will present battery charging status.		
Status	Battery voltage	LCD Display
Constant	<2V/cell	4 bars will flash in turns.
	2 ~ 2.083V/cell	Bottom bar will be on and the other three

Current mode / Constant Voltage mode	2.083 ~ 2.167V/cell	bars will flash in turns. Bottom two bars will be on and the other two bars will flash in turns.
	> 2.167 V/cell	Bottom three bars will be on and the top bar will flash.
Floating mode. Batteries are fully charged.		4 bars will be on.

In battery mode, it will present battery capacity.

Load Percentage	Battery Voltage	LCD Display
Load > 50%	< 1.85V/cell	LOW BATT
	1.85V/cell ~ 1.933V/cell	BATT
	1.933V/cell ~ 2.017V/cell	BATT
	> 2.017V/cell	BATT
Load < 50%	< 1.892V/cell	LOW BATT
	1.892V/cell ~ 1.975V/cell	BATT
	1.975V/cell ~ 2.058V/cell	BATT
	> 2.058V/cell	BATT

#### Load Information

	OVERLOAD	Indicates overload.	
	Indicates the load level by 0-24%, 25-49%, 50-74% and 75-100%.		
	0%~24%	25%~49%	
	LOAD	LOAD	
	50%~74%	75%~100%	
LOAD	LOAD	LOAD	

#### Mode Operation Information

	Indicates unit connects to the mains.
	Indicates unit connects to the PV panel.
<b>BYPASS</b>	Indicates load is supplied by utility power.
	Indicates the utility charger circuit is working.
	Indicates the solar charger circuit is working.
	Indicates the DC/AC inverter circuit is working.
	Indicates unit alarm is disabled.

	Indicates Bluetooth is connected.
	Indicates USB disk is connected.
	Time display page

## LCD Setting

### General Setting

After pressing and holding "←" button for 3 seconds, the unit will enter setting mode. Press "▲" or "▼" button to select setting programs. And then, press "←" button to confirm the selection or "⏏"/"↺" button to exit.

### Setting Programs:

Program	Description	Selectable option
00	Exit setting mode	Escape 00 * ESC
01	Output source priority: To configure load power source priority	Utility first (Default) 01 * USB
		Solar first 01 * SUB
		SBU priority 01 * SUBU

Utility will provide power to the loads as first priority. Solar and battery energy will provide power to the loads only when utility power is not available.

Solar energy provides power to the loads as first priority. If solar energy is not sufficient to power all connected loads, battery energy will supply power the loads at the same time.

Solar energy provides power to the loads as first priority. If solar energy is not sufficient to power all connected loads, battery energy will supply power to the loads at the same time. Utility provides power to the loads only when battery voltage drops to either low-level warning voltage or the setting point in program 12.



02	Maximum charging current: To configure total charging current for solar and utility chargers. (Max. charging current = utility charging current + solar charging current)	10A 02 *	20A 02 *
		10 10·	20 20·
		30A 02 *	40A 02 *
		30 30·	40 40·
03	AC input voltage range	Appliances (Default) 03 *	If selected, acceptable AC input voltage range will be within 90-280VAC.
		RPL	
		UPS 03 *	If selected, acceptable AC input voltage range will be within 170-280VAC.
		UPS	
05	Battery type	AGM (Default) 05 *	Flooded 05 *
		RCn	FLd
		User-Defined 05 *	If "User-Defined" is selected, battery charge voltage and low DC cut-off voltage can be set up in program 26, 27 and 29.
06	Auto restart when overload occurs	Restart disable (Default) 06 *	Restart enable 06 *
		Lt-d	Lt-E

07	Auto restart when over temperature occurs	Restart disable (Default) 07 *	Restart enable 07 *
		Lt-d	Lt-E
08	Solar energy feeding to grid configuration	Disable (Default) 08 *	Enable 08 *
		Gt-d	Gt-E
09	Output frequency	50Hz (Default) 09 *	60Hz 09 *
		50	60
10	Output voltage	220V 10 *	230V (Default) 10 *
		220	230
		240V 10 *	
11	Maximum utility charging current  Note: If setting value in program 02 is smaller than that in program in 11, the inverter will apply charging current from program 02 for utility charger.	2A 11 *	10A 11 *
		2	10
		20A 11 *	30A (Default) 11 *
		20	30
		40A 11 *	50A 11 *
		40	50
60A 11 *	70A 11 *	60	70
		60	70

		80A 11 *	
		80	
12	Setting voltage point back to utility source when selecting "SBU priority" in program 01.	Available options in 48V models:	
		44V 12 * 44	45V 12 * 45
		46V (Default) 12 * 46	47V 12 * 47
		48V 12 * 48	49V 12 * 49
		50V 12 * 50	51V 12 * 51
		52V 12 * 52	53V 12 * 53
		54V 12 * 54	55V 12 * 55
		56V 12 * 56	57V 12 * 57
13	Setting voltage point back to battery mode when selecting "SBU priority" or "Solar first" in program 01.	Available options in 48V models:	
		Battery fully charged 13 * FUL	48V 13 * 480

		49V 13 * 490	50V 13 * 500
		51V 13 * 510	52V 13 * 520
		53V 13 * 530	54V (Default) 13 * 540
		55V 13 * 550	56V 13 * 560
		57V 13 * 570	58V 13 * 580
		59V 13 * 590	60V 13 * 600
		61V 13 * 610	62V 13 * 620
		63V 13 * 630	64V 13 * 640
16	Charger source priority: To configure charger source priority	If this inverter/charger is working in Line, Standby or Fault mode, charger source can be programmed as below:	
		Solar first 16 * C50	Solar energy will charge battery as first priority. Utility will charge battery only when solar energy is not available.

		Solar and Utility (Default) 16 * SNU	Solar energy and utility will charge battery at the same time.
		Only Solar 16 * OSO	Solar energy will be the only charger source no matter utility is available or not.
		If this inverter/charger is working in Battery mode or Power saving mode, only solar energy can charge battery. Solar energy will charge battery if it's available and sufficient.	
18	Alarm control	Alarm on (Default) 18 * 60N	Alarm off 18 * 60F
19	Auto return to default display screen	Return to default display screen (Default) 19 * ESP	If selected, no matter how users switch display screen, it will automatically return to default display screen (Input voltage /output voltage) after no button is pressed for 1 minute.
		Stay at latest screen 19 * FEP	If selected, the display screen will stay at latest screen user finally switches.
20	Backlight control	Backlight on (Default) 20 * LON	Backlight off 20 * LOF
22	Beeps while primary source is interrupted	Alarm on (Default) 22 * RON	Alarm off 22 * ROF
23	Overload bypass: When enabled, the unit will transfer to line mode if overload occurs in battery mode.	Bypass disable (Default) 23 * 6YD	Bypass enable 23 * 6YE

25	Record Fault code	Record enable 25 * FEN	Record disable (Default) 25 * FDS
26	Bulk charging voltage (C.V voltage)	default setting: 56.4V 26 * CV 56.4	If self-defined is selected in program 5, this program can be set up. Setting range is from 48.0V to 64.0V. Increment of each click is 0.1V.
27	Floating charging voltage	default setting: 54.0V 27 * FLV 54.0	If self-defined is selected in program 5, this program can be set up. Setting range is from 48.0V to 64.0V. Increment of each click is 0.1V.
28	AC output mode *This setting is only available when the inverter is in standby mode (Switch off).	Single: This inverter is used in single phase application. 28 * SIG L1 phase: 28 * 3P1 L3 phase: 28 * 3P3	Parallel: This inverter is operated in parallel system. 28 * PAR L2 phase: 28 * 3P2
29	Low DC cut-off voltage	default setting: 42.0V 29 * COV 42.0	If self-defined is selected in program 5, this program can be set up. Setting range is from 40.0V to 54.0V. Increment of each click is 0.1V. Low DC cut-off voltage will be fixed to setting value no matter what percentage of load is connected.
32	Bulk charging time (C.V stage)	Automatically (Default): 32 * AUT	If selected, inverter will judge this charging time automatically.

		5 min 32 *  5 900 min 32 * 900	The setting range is from 5 min to 900 min. Increment of each click is 5 min.
		If "USE" is selected in program 05, this program can be set up.	
33	Battery equalization	Battery equalization 33 * EEN	Battery equalization disable (Default) 33 * EDS
		If "Flooded" or "User-Defined" is selected in program 05, this program can be set up.	
34	Battery equalization voltage	Default setting is 58.4V. 34 * EV 58.4	Setting range is from 48V ~ 64V. Increment of each click is 0.1V.
35	Battery equalized time	60min (Default) 35 * 60	Setting range is from 5min to 900min. Increment of each click is 5min.
36	Battery equalized timeout	120min (Default) 36 * 120	Setting range is from 5min to 900 min. Increment of each click is 5 min.
37	Equalization interval	30days (Default) 37 * 30d	Setting range is from 0 to 90 days. Increment of each click is 1 day
39	Equalization activated immediately	Enable 39 * REN	Disable (Default) 39 * RDS

		If equalization function is enabled in program 33, this program can be set up. If "Enable" is selected in this program, it's to activate battery equalization immediately and LCD main page will shows "E9". If "Disable" is selected, it will cancel equalization function until next activated equalization time arrives based on program 37 setting. At this time, "E9" will not be shown in LCD main page.	
40	Reset PV and Load energy storage	Not reset (Default) 40 * nrt	Reset 40 * rst
93	Erase all data log	Not reset(Default) 93 * nrt	Reset 93 * rst
94	Data log stored period	3 days 94 * 3 10 days (Default) 94 * 10	5 days 94 * 5 20 days 94 * 20
		30 days 94 * 30	60 days 94 * 60
95	Time setting – Minute	For minute setting, the range is from 00 to 59. 95 * nrt 00	
96	Time setting – Hour	For hour setting, the range is from 00 to 23. 96 * HOV 00	
97	Time setting– Day	For day setting, the range is from 00 to 31. 97 * DAY 01	

98	Time setting- Month	For month setting, the range is from 01 to 12. 98 * 01
99	Time setting - Year	For year setting, the range is from 17 to 99. 99 * YEAR 17

## Function Setting

There are three function keys on the display panel to implement special functions such as USB OTG, Timer setting for output source priority and timer setting for charger source priority.

### 1. USB Function Setting

Please insert USB disk into USB port ( ). Press and hold button for 3 seconds to enter USB function setting mode. These functions include to upgrade inverter firmware, export data log and re-write internal parameters from USB disk.

<b>Procedure</b>	LCD Screen
<b>Step 1:</b> Press and hold  button for 3 seconds to enter USB function setting mode.	UPG *
<b>Step 2:</b> Press  or  button to enter the selectable setting programs.	SET LOG

**Step 3:** Please select setting program by following each procedure.

Program#	Operation Procedure	LCD Screen
: Upgrade firmware	If pressing  button to proceed the firmware upgrade function. If the selected function is ready, LCD will display "UDY". Please press  button to confirm the selection again. Press  to select "Yes" or  button to select "No". Then, press  button to exit setting mode.	UPG * UDY UPG * YES NO
: Re-write internal parameters	If pressing  button to proceed parameters re-write from USB function. If selected function is ready, LCD will display "UDY". Please press  button to confirm the selection again. Press  to select "Yes" or  button to select "No". Then, press  button to exit setting mode. <b>IMPORTANT NOTE:</b> After this function is executed, partial LCD setting programs will be locked. For the detailed information, please check your installer directly.	SET * UDY SET * YES NO

: Export data log	If pressing  button to export data log from USB disk to the inverter. If selected function is ready, LCD will display "UDY". Please press  button to confirm the selection again. Press  to select "Yes" or  button to select "No". Then, press  button to exit setting mode.	LOG * UDY LOG * YES NO
----------------------	--	------------------------------------

If no button is pressed for 1 minute, it will automatically return to main screen.

### Error message for USB On-the-Go functions:

Error Code	Messages
U01	No USB disk is detected.
U02	USB disk is protected from copy.
U03	Document inside the USB disk with wrong format.

If any error occurs, error code will only show 3 seconds. After three seconds, it will automatically return to display screen.

### 2. Timer Setting for Output Source Priority

This timer setting is to set up the output source priority per day.

<b>Procedure</b>	LCD Screen
<b>Step 1:</b> Press and hold  button for 3 seconds to enter timer setting mode for output source priority.	USB * SUB
<b>Step 2:</b> Press ,  or  button to enter the selectable setting programs.	SVU



**Step 3:** Please select setting program by following each procedure.

Program#	Operation Procedure	LCD Screen
	If pressing  button to set up timer. Press  to select start time. Press  or  button to set the start time and then press  button to confirm. Press  button to select end time. Press  or  button to set the end time and then press  button to confirm. The setting range is from 00 to 23. Increment of each click is 1 hour.	USB * 00 23
	If pressing  button to set up timer. Press  to select start time. Press  or  button to set the start time and then press  button to confirm. Press  button to select end time. Press  or  button to set the end time and then press  button to confirm. The setting range is from 00 to 23. Increment of each click is 1 hour.	SUB * 00 23
	If pressing  button to set up timer. Press  to select start time. Press  or  button to set the start time and then press  button to confirm. Press  button to select end time. Press  or  button to set the end time and then press  button to confirm. The setting range is from 00 to 23. Increment of each click is 1 hour.	SVU * 00 23









Press button to exit setting mode.

### 3. Timer Setting for the Charger Source Priority

This timer setting is to set up the charger source priority per day.

Procedure	LCD Screen
<b>Step 1:</b> Press and hold "☰/☷" button for 3 seconds to enter timer setting mode for charger source priority.	  
<b>Step 2:</b> Press "☰/☷", "☰/☷" or "☰/☷" button to enter the selectable setting programs.	





**Step 3:** Please select setting program by following each procedure.

Program#	Operation Procedure	LCD Screen
☰/☷	If pressing "☰/☷" button to set up timer. Press "☰/☷" to select start time. Press "▲" or "▼" button to set the start time and then press "←" button to confirm. Press "☰/☷" button to select end time. Press "▲" or "▼" button to set the end time and then press "←" button to confirm. The setting range is from 00 to 23. Increment of each click is 1 hour.	  
☰/☷	If pressing "☰/☷" button to set up timer. Press "☰/☷" to select start time. Press "▲" or "▼" button to set the start time and then press "←" button to confirm. Press "☰/☷" button to select end time. Press "▲" or "▼" button to set the end time and then press "←" button to confirm. The setting range is from 00 to 23. Increment of each click is 1 hour.	  
☰/☷	If pressing "☰/☷" button to set up timer. Press "☰/☷" to select start time setting. Press "▲" or "▼" button to set the start time and then press "←" button to confirm. Press "☰/☷" button to select end time. Press "▲" or "▼" button to set the end time and then press "←" button to confirm. The setting range is from 00 to 23. Increment of each click is 1 hour.	  

Press "☰/☷" button to exit setting mode.

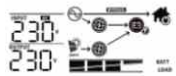
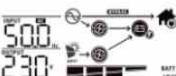
### Display Setting

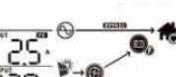

The LCD display information will be switched in turns by pressing "▲" or "▼" key. The selectable information is switched as the following table in order.

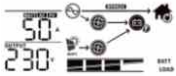
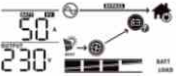
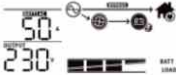
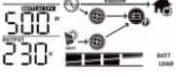
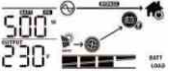
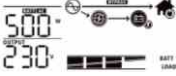
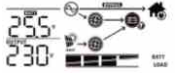
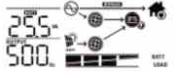
Selectable information	LCD display
Input voltage/output voltage (Default Display Screen)	Input Voltage=230V, output voltage=230V 
Input frequency	Input frequency=50Hz 
PV voltage	PV voltage=260V 
PV current	PV current = 2.5A 
PV power	PV power = 500W 

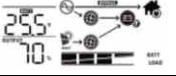
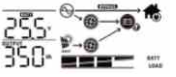
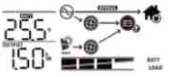
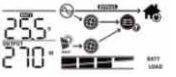
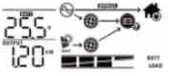
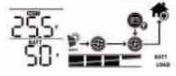
Charging current	<p>AC and PV charging current=50A</p>  <p>PV charging current=50A</p>  <p>AC charging current=50A</p> 
Charging power	<p>AC and PV charging power=500W</p>  <p>PV charging power=500W</p>  <p>AC charging power=500W</p> 
Battery voltage and output voltage	<p>Battery voltage=25.5V, output voltage=230V</p> 
Output frequency	<p>Output frequency=50Hz</p> 

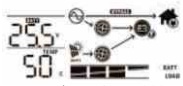
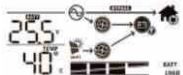
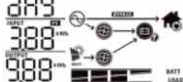
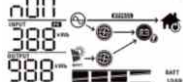
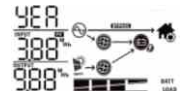
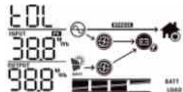
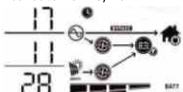

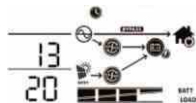

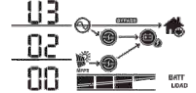

Load percentage	<p>Load percent=70%</p> 
Load in VA	<p>When connected load is lower than 1kVA, load in VA will present xxxVA like below chart.</p>  <p>When load is larger than 1kVA (<math>\geq 1\text{kVA}</math>), load in VA will present x.xkVA like below chart.</p> 
Load in Watt	<p>When load is lower than 1kW, load in W will present xxxW like below chart.</p>  <p>When load is larger than 1kW (<math>\geq 1\text{kW}</math>), load in W will present x.xkW like below chart.</p> 
Battery voltage/DC discharging current	<p>Battery voltage=25.5V, discharging current=50A</p> 



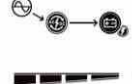

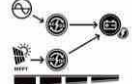
<p>Battery voltage/Inverter temperature and Solar charger controller temperature inside (Inverter temperature and SCC temperature is displayed in turns)</p>	<p>Battery voltage=25.5V, Inverter temperature =50°C</p>  <p>Battery voltage=25.5V, SCC temperature =40°C</p> 
<p>PV energy generated today and Load output energy today</p>	<p>This PV Today energy = 3.88kWh, Load Today energy= 9.88kWh.</p> 
<p>PV energy generated this month and Load output energy this month.</p>	<p>This PV month energy = 388kWh, Load month energy= 988kWh.</p> 
<p>PV energy generated this year and Load output energy this year.</p>	<p>This PV year energy = 3.88MWh, Load year energy = 9.88MWh.</p> 
<p>PV energy generated totally and Load output total energy.</p>	<p>PV Total energy = 38.8MWh, Load Output Total energy = 98.8MWh.</p> 
<p>Real date.</p>	<p>Real date Nov 28, 2017.</p> 

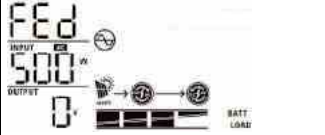
<p>Real time.</p>	<p>Real time 13:20.</p> 
<p>Main CPU version checking.</p>	<p>Main CPU version 00072.10.</p> 
<p>Secondary CPU version checking.</p>	<p>Secondary CPU version 00001.22.</p> 
<p>Bluetooth version checking.</p>	<p>Bluetooth version 00002.00.</p> 

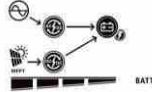

## Operating Mode Description

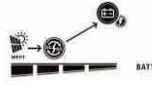
Operating mode	Behaviors	LCD display
<p>Standby mode / Power saving mode</p> <p><b>Note:</b></p> <p>*Standby mode: The inverter is not turned on yet but at this time, the inverter can charge battery without AC output.</p> <p>*Power saving mode: If enabled, the output of inverter will be off when connected load is pretty low or not detected.</p>	<p>No output is supplied by the unit but it still can charge batteries.</p>	<p>Battery is charged by utility.</p> 
		<p>Battery is charged by PV energy.</p> 
		<p>Battery is charged by utility and PV energy.</p> 
		<p>No charging.</p> 
		<p>Power is generated from PV energy only and PV energy feeds to grid when battery is not connected. It will have "FED" text and "output" icon flashing in the LCD screen.</p>  <p>PV energy charges battery and feeds remaining energy to the grid. It will have "FED" text and "output" icon flashing in the LCD screen.</p> 

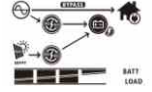
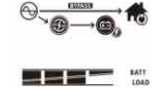
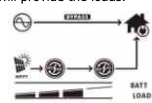
<p>Fault mode</p> <p>Note:</p> <p>*Fault mode: Errors are caused by inside circuit error or external reasons such as over temperature, output short circuited and so on.</p>	<p>PV energy and utility can charge batteries.</p>	<p>Charging by utility and PV energy.</p> 
		<p>Charging by utility.</p> 
<p>Line mode</p>	<p>Output power from utility. Charger is available.</p>	<p>Charging by PV energy.</p> 
		<p>No charging.</p> 
		<p>Charging by utility and PV energy.</p> 
		<p>Charging by utility.</p> 
		<p>Battery is not connected, solar energy and the utility will provide the loads.</p> 

Line mode	Output power from utility. Charger is available.	<p>Power from utility.</p>
		<p>Power from PV energy only and feed PV energy to grid when battery is not connected. It will have "FED" flashing in the LCD screen.</p>
		<p>PV energy charges battery provides power to the load and feeds remaining energy to the grid. It will have "FED" flashing in the LCD screen.</p>
Battery mode	Output power from battery or PV	<p>Power from battery and PV energy.</p>
		<p>PV energy will supply power to the loads and charge battery at the same time. No utility is available.</p>
		<p>Power from battery only.</p>
		<p>Power from PV energy only.</p>

## Faults Reference Code

Fault Code	Fault Event	Icon on
01	Fan is locked when inverter is off.	F01
02	Over temperature	F02
03	Battery voltage is too high	F03
04	Battery voltage is too low	F04
05	Output short circuited or over temperature is detected by internal converter components.	F05
06	Output voltage is too high.	F06
07	Overload time out	F07
08	Bus voltage is too high	F08
09	Bus soft start failed	F09
10	PV over current	F10
11	PV over voltage	F11
12	DCDC over current	F12
51	Over current or surge	F51
52	Bus voltage is too low	F52
53	Inverter soft start failed	F53
55	Over DC voltage in AC output	F55
57	Battery connection is open	F57
58	Current sensor failed	F58

## Warning Indicator

Warning Code	Warning Event	Audible Alarm	Icon flashing
01	Fan is locked when inverter is on.	Beep three times every second	01 <sup>△</sup>
02	Over temperature	None	02 <sup>△</sup>
03	Battery is over-charged	Beep once every second	03 <sup>△</sup>
04	Low battery	Beep once every second	04 <sup>△</sup>
07	Overload	Beep once every 0.5 second	07 <sup>△</sup> 
10	Output power derating	Beep twice every 3 seconds	10 <sup>△</sup>
32	Communication interrupted	None	32 <sup>△</sup>
Eq	Battery equalization	None	Eq <sup>△</sup>
bP	Battery is not connected	None	bP <sup>△</sup>

## BATTERY EQUALIZATION

Equalization function is added into charge controller. It reverses the buildup of negative chemical effects like stratification, a condition where acid concentration is greater at the bottom of the battery than at the top. Equalization also helps to remove sulfate crystals that might have built up on the plates. If left unchecked, this condition, called sulfation, will reduce the overall capacity of the battery. Therefore, it's recommended to equalize battery periodically.

### ● How to Apply Equalization Function

You must enable battery Equalization function in monitoring LCD setting program 33 first. Then, you may apply this function in device by either one of following methods:

1. Setting equalization interval in program 37.
2. Active equalization immediately in program 39.

### ● When to Equalize

In float stage, when the setting equalization interval (battery equalization cycle) is arrived, or equalization is active immediately, the controller will start to enter Equalize stage.

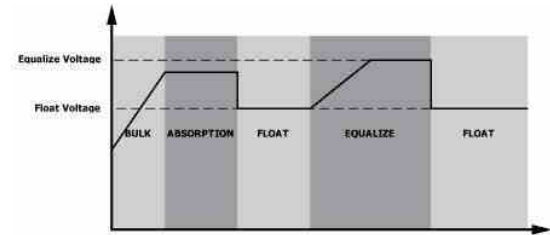

### ● Equalize charging time and timeout

In Equalize stage, the controller will supply power to charge battery as much as possible until battery voltage raises to battery equalization voltage. Then, constant-voltage regulation is applied to maintain battery voltage at the battery equalization voltage. The battery will remain in the Equalize stage until setting battery equalized time is arrived.

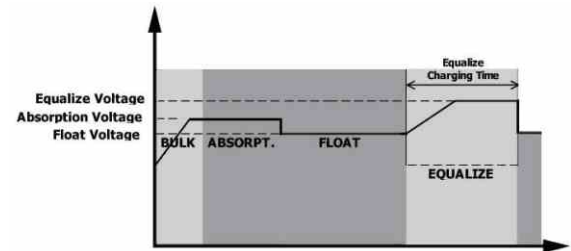

However, in Equalize stage, when battery equalized time is expired and battery voltage doesn't rise to battery equalization voltage point, the charge controller will extend the battery equalized time until battery voltage achieves battery equalization voltage. If battery voltage is still lower than battery equalization voltage when battery equalized timeout setting is over, the charge controller will stop equalization and return to float stage.

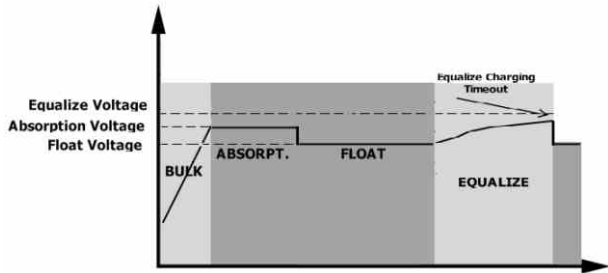

## SPECIFICATIONS

Table 1 Line Mode Specifications

INVERTER MODEL	5KW
<b>Input Voltage Waveform</b>	Sinusoidal (utility or generator)
<b>Nominal Input Voltage</b>	230Vac
<b>Low Loss Voltage</b>	170Vac±7V (UPS) 90Vac±7V (Appliances)
<b>Low Loss Return Voltage</b>	180Vac±7V (UPS); 100Vac±7V (Appliances)
<b>High Loss Voltage</b>	280Vac±7V
<b>High Loss Return Voltage</b>	270Vac±7V
<b>Max AC Input Voltage</b>	300Vac
<b>Nominal Input Frequency</b>	50Hz / 60Hz (Auto detection)
<b>Low Loss Frequency</b>	40±1Hz
<b>Low Loss Return Frequency</b>	42±1Hz
<b>High Loss Frequency</b>	65±1Hz
<b>High Loss Return Frequency</b>	63±1Hz
<b>Output Short Circuit Protection</b>	Line mode: Circuit Breaker Battery mode: Electronic Circuits
<b>Efficiency (Line Mode)</b>	>95% ( Rated R load, battery full charged )
<b>Transfer Time</b>	10ms typical (UPS); 20ms typical (Appliances)
<b>Output power derating:</b> When AC input voltage drops to 95V or 170V depending on models, the output power will be derated.	

Table 2 Inverter Mode Specifications

INVERTER MODEL	5KW
<b>Rated Output Power</b>	5KVA/5KW
<b>Output Voltage Waveform</b>	Pure Sine Wave
<b>Output Voltage Regulation</b>	230Vac±5%
<b>Output Frequency</b>	60Hz or 50Hz
<b>Peak Efficiency</b>	90%
<b>Overload Protection</b>	5s@≥150% load; 10s@110%~150% load
<b>Surge Capacity</b>	2* rated power for 5 seconds
<b>Nominal DC Input Voltage</b>	48Vdc
<b>Cold Start Voltage</b>	46.0Vdc
<b>Low DC Warning Voltage</b> @ load < 20%	44.0Vdc
@ 20% ≤ load < 50%	42.8Vdc
@ load ≥ 50%	40.4Vdc
<b>Low DC Warning Return Voltage</b> @ load < 20%	46.0Vdc
@ 20% ≤ load < 50%	44.8Vdc
@ load ≥ 50%	42.4Vdc
<b>Low DC Cut-off Voltage</b> @ load < 20%	42.0Vdc
@ 20% ≤ load < 50%	40.8Vdc
@ load ≥ 50%	38.4Vdc
<b>High DC Recovery Voltage</b>	62Vdc
<b>High DC Cut-off Voltage</b>	64Vdc

Table 3 Charge Mode Specifications

Utility Charging Mode		5KW
<b>INVERTER MODEL</b>		
<b>Charging Current (UPS)</b> @ Nominal Input Voltage		80A
<b>Bulk Charging Voltage</b>	<b>Flooded Battery</b>	58.4
	<b>AGM / Gel Battery</b>	56.4
<b>Floating Charging Voltage</b>		54Vdc
<b>Overcharge Protection</b>		64Vdc
<b>Charging Algorithm</b>		3-Step
<b>Charging Curve</b>		
	<b>Solar Input</b>	
<b>INVERTER MODEL</b>		<b>5KVA</b>
<b>Rated Power</b>		5000W
<b>Max. PV Array Open Circuit Voltage</b>		450Vdc
<b>PV Array MPPT Voltage Range</b>		120Vdc~430Vdc
<b>Max. Input Current</b>		18A

Table 4 General Specifications

INVERTER MODEL	5KW
Safety Certification	CE
Operating Temperature Range	-10°C to 50°C
Storage temperature	-15°C~ 60°C
Humidity	5% to 95% Relative Humidity (Non-condensing)
Dimension (D*W*H), mm	140 x 295 x 468
Net Weight, kg	12

## TROUBLE SHOOTING

Problem	LCD/LED/Buzzer	Explanation / Possible cause	What to do
Unit shuts down automatically during startup process.	LCD/LEDs and buzzer will be active for 3 seconds and then complete off.	The battery voltage is too low (<1.91V/Cell)	1. Re-charge battery. 2. Replace battery.
No response after power on.	No indication.	1. The battery voltage is far too low. (<1.4V/Cell) 2. Battery polarity is connected reversed.	1. Check if batteries and the wiring are connected well. 2. Re-charge battery. 3. Replace battery.
Mains exist but the unit works in battery mode.	Input voltage is displayed as 0 on the LCD and green LED is flashing.	Input protector is tripped	Check if AC breaker is tripped and AC wiring is connected well.
	Green LED is flashing.	Insufficient quality of AC power. (Shore or Generator)	1. Check if AC wires are too thin and/or too long. 2. Check if generator (if applied) is working well or if input voltage range setting is correct. (UPS→Appliance)
	Green LED is flashing.	Set "Solar First" as the priority of output source.	Change output source priority to Utility first.
When the unit is turned on, internal relay is switched on and off repeatedly.	LCD display and LEDs are flashing	Battery is disconnected.	Check if battery wires are connected well.
Buzzer beeps continuously and red LED is on.	Fault code 07	Overload error. The inverter is overload 110% and time is up.	Reduce the connected load by switching off some equipment.
	Fault code 05	Output short circuited.	Check if wiring is connected well and remove abnormal load.
		Temperature of internal converter component is over 120°C. (Only available for 1-3KVA models.)	Check whether the air flow of the unit is blocked or whether the ambient temperature is too high.
	Fault code 02	Internal temperature of inverter component is over 100°C.	
	Fault code 03	Battery is over-charged.	Return to repair center.
		The battery voltage is too high.	Check if spec and quantity of batteries are meet requirements.
	Fault code 01	Fan fault	Replace the fan.
	Fault code 06/58	Output abnormal (Inverter voltage below than 190Vac or is higher than 260Vac)	1. Reduce the connected load. 2. Return to repair center
	Fault code 08/09/53/57	Internal components failed.	Return to repair center.
	Fault code 51	Over current or surge.	Restart the unit, if the error happens again, please return to repair center.
	Fault code 52	Bus voltage is too low.	
Fault code 55	Output voltage is unbalanced.		
Fault code 56	Battery is not connected well or fuse is burnt.	If the battery is connected well, please return to repair center.	

## Appendix I: Parallel function

### 1. Introduction

This inverter can be used in parallel with two different operation modes.

1. Parallel operation in single phase with up to 9 units. The supported maximum output power is 46.8KW/46.8KVA.
2. Maximum nine units work together to support three-phase equipment. Seven units support one phase maximum. The supported maximum output power is 46.8KW/46.8KVA and one phase can be up to 36.4KW/36.4KVA.

**NOTE:** If this unit is bundled with share current cable and parallel cable, this inverter is default supported parallel operation. You may skip section 3. If not, please purchase parallel kit and install this unit by following instruction from professional technical personnel in local dealer.

### 2. Package Contents

In parallel kit, you will find the following items in the package:

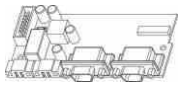

Parallel board



Parallel communication cable



Current sharing cable

### 3. Parallel board installation

**Step 1:** Remove wire cover by unscrewing all screws.

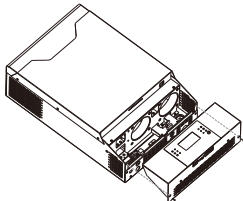

**Step 2:** Remove two screws as below chart and remove 2-pin and 14-pin cables. Take out the board under the communication board.

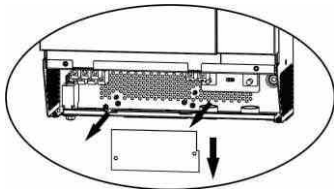

**Step 3:** Remove two screws as below chart to take out cover of parallel communication.

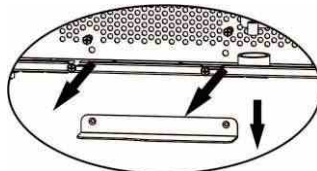

**Step 4:** Install new parallel board with 2 screws tightly.

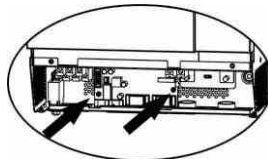

**Step 6:** Connect 2-pin to original position.

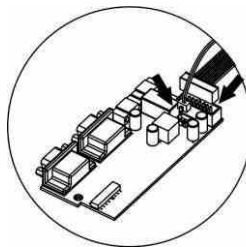

**Step 7:** Put communication board back to the unit.

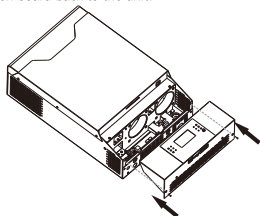

**Step 8:** Put wire cover back to the unit. Now the inverter is providing parallel operation function.

#### 4. Mounting the Unit

When installing multiple units, please follow below chart.

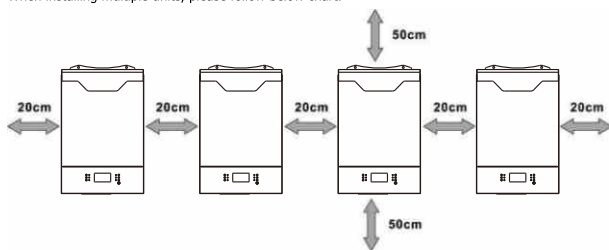

**NOTE:** For proper air circulation to dissipate heat, allow a clearance of approx. 20 cm to the side and approx. 50 cm above and below the unit. Be sure to install each unit in the same level.

#### 5. Wiring Connection

**NOTICE:** It's requested to connect to battery for parallel operation.

The cable size of each inverter is shown as below:

##### Recommended battery cable and terminal size for each inverter:

Model	Wire Size	Ring Terminal			Torque value
		Cable mm <sup>2</sup>	Dimensions		
			D (mm)	L (mm)	
5KW	2*4 AWG	44	6.4	49.7	2~3

**WARNING:** Be sure the length of all battery cables is the same. Otherwise, there will be voltage difference between inverter and battery to cause parallel inverters not working.

##### Recommended AC input and output cable size for each inverter:

Ring terminal:

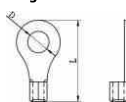

Model	AWG no.	Torque
5KW	10 AWG	1.2~ 1.6Nm

You need to connect the cables of each inverter together. Take the battery cables for example: You need to use a connector or bus-bar as a joint to connect the battery cables together, and then connect to the battery terminal. The cable size used from joint to battery should be X times cable size in the tables above. "X" indicates the number of inverters connected in parallel.

Regarding AC input and output, please also follow the same principle.

**CAUTION!!** Please install the breaker at the battery and AC input side. This will ensure the inverter can be securely disconnected during maintenance and fully protected from over current of battery or AC input. The recommended mounted location of the breakers is shown in the figures in 5-1 and 5-2.

##### Recommended breaker specification of battery for each inverter:

Model	1 unit*
5KW	80A/70VDC

\*If you want to use only one breaker at the battery side for the whole system, the rating of the breaker should be X times current of 1 unit. "X" indicates the number of inverters connected in parallel.

##### Recommended breaker specification of AC input with single phase:

Model	2 units	3 units	4 units	5 units	6 units	7 units	8 units	9 units
5KW	80A/	120A/	160A/	200A/	240A/	280A/	320A/	360A/
	230VAC	230VAC	230VAC	230VAC	230VAC	230VAC	230VAC	230VAC

**Note1:** Also, you can use 50A breaker for 4KW/5KW for only 1 unit and install one breaker at its AC input in each inverter.

**Note2:** Regarding three-phase system, you can use 4-pole breaker directly and the rating of the breaker should be compatible with the phase current limitation from the phase with maximum units

##### Recommended battery capacity

Inverter parallel numbers	2	3	4	5	6	7	8	9
Battery Capacity for 5.2KW	200AH	400AH	400AH	600AH	600AH	800AH	800AH	1000AH

**WARNING!** Be sure that all inverters will share the same battery bank. Otherwise, the inverters will transfer to fault mode.



## 5-1. Parallel Operation in Single phase

Two inverters in parallel:

**Power Connection**

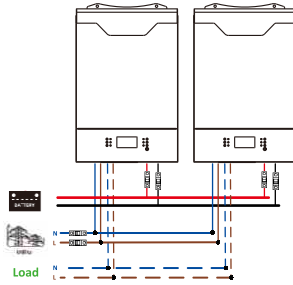

**Communication Connection**

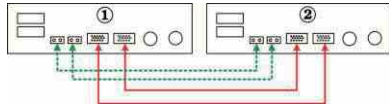

Three inverters in parallel:

**Power Connection**

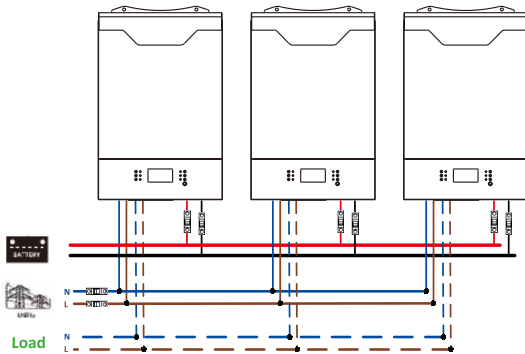

**Communication Connection**

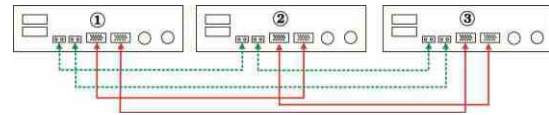

Four inverters in parallel:

**Power Connection**

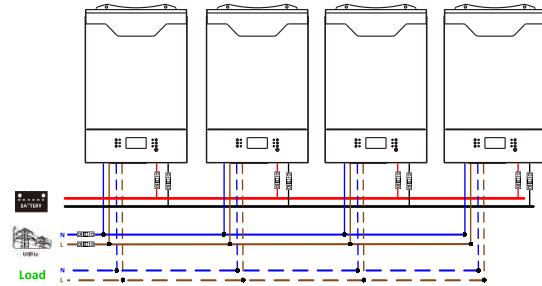

**Communication Connection**

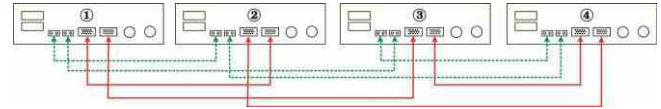

Five inverters in parallel:

**Power Connection**

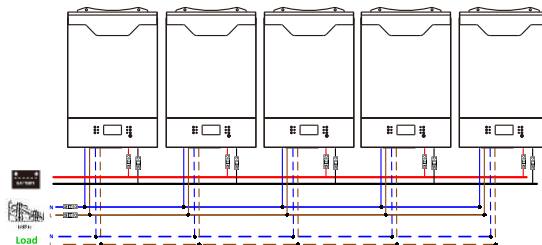

### Communication Connection

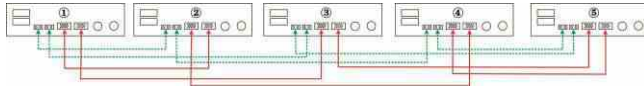

Six inverters in parallel:

### Power Connection

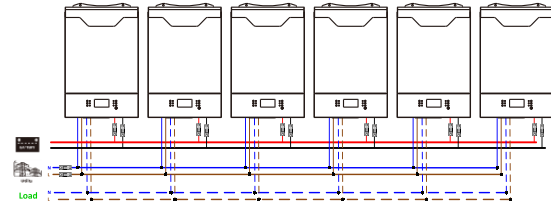

### Communication Connection

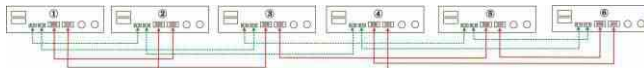

Seven inverters in parallel:

### Power Connection

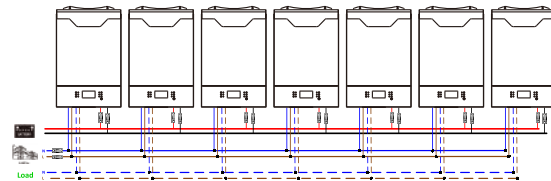

### Communication Connection

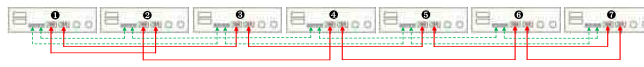

Eight inverters in parallel:

### Power Connection

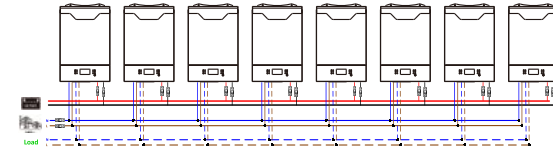

### Communication Connection



Nine inverters in parallel:

### Power Connection

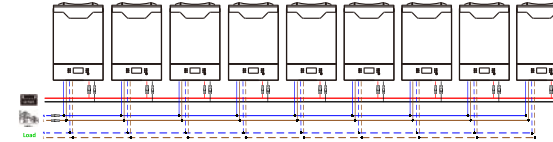

### Communication Connection



## 5-2. Support 3-phase equipment

Three inverters in each phase:

### Power Connection

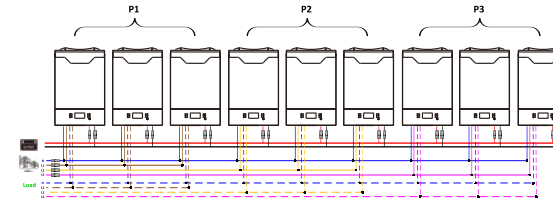

### Communication Connection



Three inverters in one phase, three inverters in second phase and two inverter for the third phase:

**Power Connection**

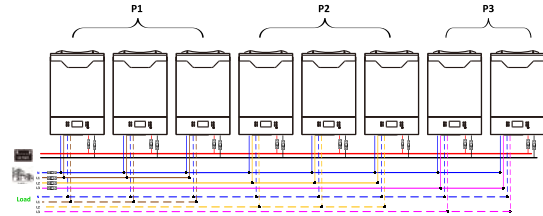

**Communication Connection**



Three inverters in one phase, two inverters in second phase and two inverters for the third phase:

**Power Connection**

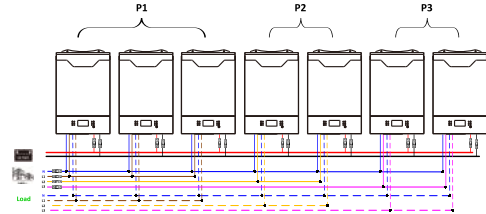

**Communication Connection**



Two inverters in each phase:

**Power Connection**

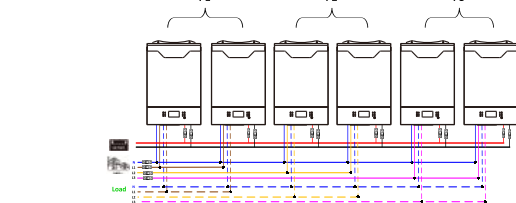

**Communication Connection**

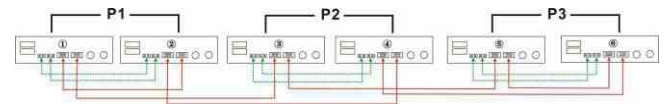

Seven inverters in one phase and one inverter for the other two phases:

**Power Connection**

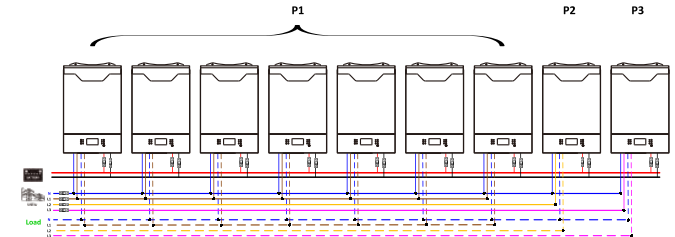

**Note:** It's up to customer's demand to pick 7 inverters on any phase.

P1: L1-phase, P2: L2-phase, P3: L3-phase.

**Communication Connection**

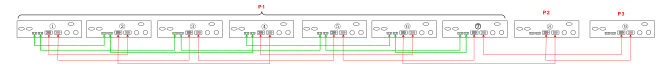

**Note:** If there is only one unit in one phase, this unit doesn't need to connect the current sharing cable.

Or you connect it like as below:



Four inverters in one phase and one inverter for the other two phases:

**Power Connection**

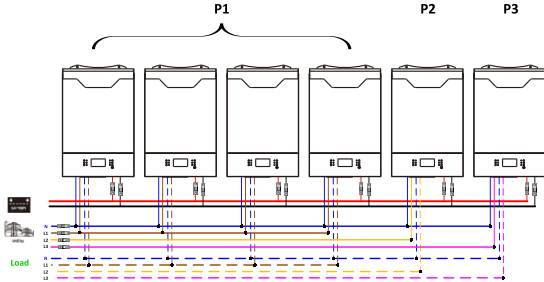

**Communication Connection**



Three inverters in one phase, two inverters in second phase and one inverter for the third phase:

**Power Connection**

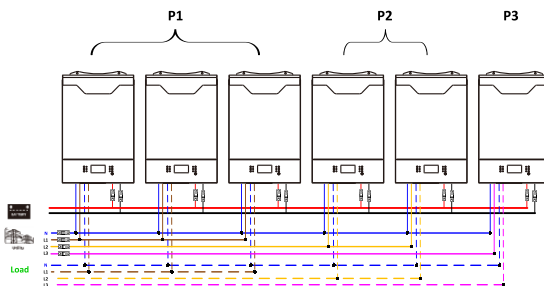

**Communication Connection**

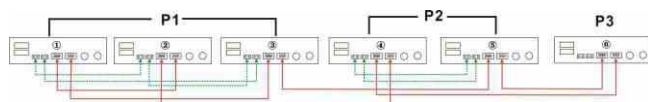

Three inverters in one phase and only one inverter for the remaining two phases:

**Power Connection**

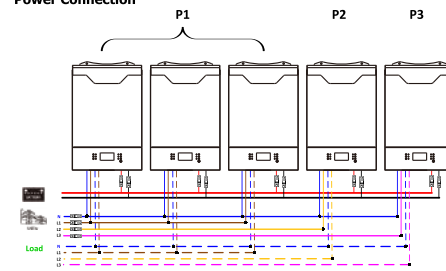

**Communication Connection**

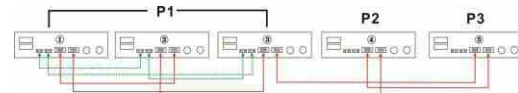

Two inverters in two phases and only one inverter for the remaining phase:

**Power Connection**

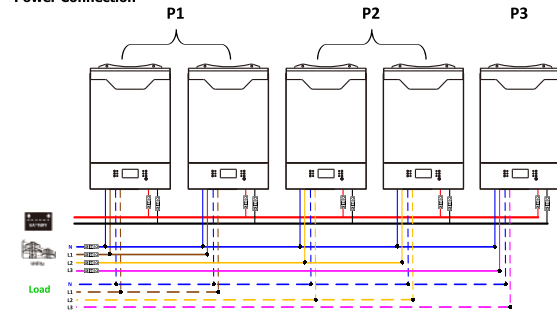

**Communication Connection**

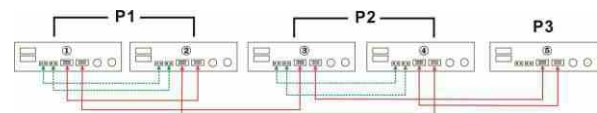

Two inverters in one phase and only one inverter for the remaining phases:

**Power Connection**

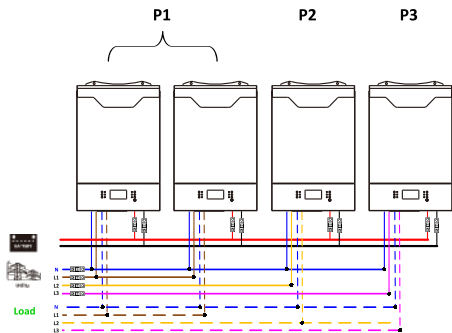

**Communication Connection**

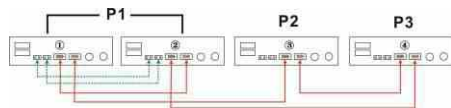

One inverter in each phase:

**Power Connection**

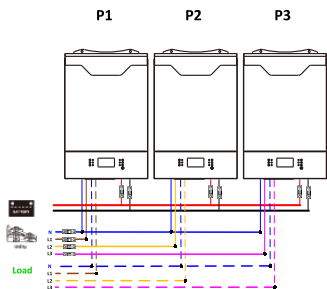

**Communication Connection**

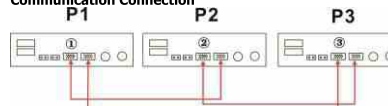

**WARNING:** Do not connect the current sharing cable between the inverters which are in different phases. Otherwise, it may damage the inverters.

**6. PV Connection**

Please refer to user manual of single unit for PV Connection.

**CAUTION:** Each inverter should connect to PV modules separately.

## 7. LCD Setting and Display

### Setting Program:

Program	Description	Selectable option
28	AC output mode *This setting is only available when the inverter is in standby mode (Switch off).	Single: 28 *
		51 0
		Parallel: 28 *
		PAL
		L1 phase: 28 *
		3P1
		L2 phase: 28 *
3P2		
L3 phase: 28 *		
3P3		

When the units are used in parallel with single phase, please select "PAL" in program 28.

It is required to have at least 3 inverters or maximum 6 inverters to support three-phase equipment. It's required to have at least one inverter in each phase or it's up to four inverters in one phase. Please refers to 5-2 for detailed information.

Please select "3P1" in program 28 for the inverters connected to L1 phase, "3P2" in program 28 for the inverters connected to L2 phase and "3P3" in program 28 for the inverters connected to L3 phase.

Be sure to connect share current cable to units which are on the same phase. Do NOT connect share current cable between units on different phases.

### Fault code display:

Fault Code	Fault Event	Icon on
60	Power feedback protection	F60
71	Firmware version inconsistent	F71
72	Current sharing fault	F72
80	CAN fault	F80
81	Host loss	F81
82	Synchronization loss	F82
83	Battery voltage detected different	F83
84	AC input voltage and frequency detected different	F84
85	AC output current unbalance	F85
86	AC output mode setting is different	F86

## 8. Commissioning

### Parallel in single phase

Step 1: Check the following requirements before commissioning:

- Correct wire connection
- Ensure all breakers in Line wires of load side are open and each Neutral wires of each unit are connected together.

Step 2: Turn on each unit and set "PAL" in LCD setting program 28 of each unit. And then shut down all units. **NOTE:** It's necessary to turn off switch when setting LCD program. Otherwise, the setting can not be programmed.

Step 3: Turn on each unit.

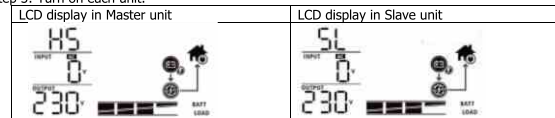

**NOTE:** Master and slave units are randomly defined.

Step 4: Switch on all AC breakers of Line wires in AC input. It's better to have all inverters connected to utility at the same time. If not, it will display fault 82 in following-order inverters. However, these inverters will automatically restart. If detecting AC connection, they will work normally.

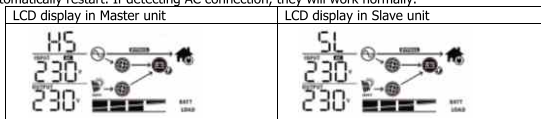

Step 5: If there is no more fault alarm, the parallel system is completely installed.

Step 6: Please switch on all breakers of Line wires in load side. This system will start to provide power to the load.

### Support three-phase equipment

Step 1: Check the following requirements before commissioning:

- Correct wire connection
- Ensure all breakers in Line wires of load side are open and each Neutral wires of each unit are connected together.

Step 2: Turn on all units and configure LCD program 28 as P1, P2 and P3 sequentially. And then shut down all units.

**NOET:** It's necessary to turn off switch when setting LCD program. Otherwise, the setting can not be programmed.

Step 3: Turn on all units sequentially.

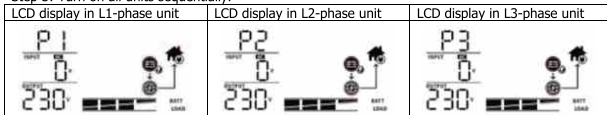

Step 4: Switch on all AC breakers of Line wires in AC input. If AC connection is detected and three phases are matched with unit setting, they will work normally. Otherwise, the AC icon will flash and they will not work in line mode.

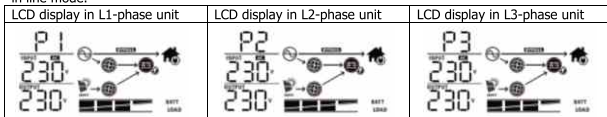

Step 5: If there is no more fault alarm, the system to support 3-phase equipment is completely installed.

Step 6: Please switch on all breakers of Line wires in load side. This system will start to provide power to the load.

Note 1: To avoid overload occurring, before turning on breakers in load side, it's better to have whole system in operation first.

Note 2: Transfer time for this operation exists. Power interruption may happen to critical devices, which cannot bear transfer time.

## 9. Trouble shooting

Situation		Solution
Fault Code	Fault Event Description	
60	Current feedback into the inverter is detected.	<ol style="list-style-type: none"> <li>1. Restart the inverter.</li> <li>2. Check if L/N cables are not connected reversely in all inverters.</li> <li>3. For parallel system in single phase, make sure the sharing are connected in all inverters. For supporting three-phase system, make sure the sharing cables are connected in the inverters in the same phase, and disconnected in the inverters in different phases.</li> <li>4. If the problem remains, please contact your installer.</li> </ol>
71	The firmware version of each inverter is not the same.	<ol style="list-style-type: none"> <li>1. Update all inverter firmware to the same version.</li> <li>2. Check the version of each inverter via LCD setting and make sure the CPU versions are same. If not, please contact your installer to provide the firmware to update.</li> <li>3. After updating, if the problem still remains, please contact your installer.</li> </ol>
72	The output current of each inverter is different.	<ol style="list-style-type: none"> <li>1. Check if sharing cables are connected well and restart the inverter.</li> <li>2. If the problem remains, please contact your installer.</li> </ol>
80	CAN data loss	<ol style="list-style-type: none"> <li>1. Check if communication cables are connected well and restart the inverter.</li> <li>2. If the problem remains, please contact your installer.</li> </ol>
81	Host data loss	
82	Synchronization data loss	
83	The battery voltage of each inverter is not the same.	<ol style="list-style-type: none"> <li>1. Make sure all inverters share same groups of batteries together.</li> <li>2. Remove all loads and disconnect AC input and PV input. Then, check battery voltage of all inverters. If the values from all inverters are close, please check if all battery cables are the same length and same material type. Otherwise, please contact your installer to provide SOP to calibrate battery voltage of each inverter.</li> <li>3. If the problem still remains, please contact your installer.</li> </ol>
84	AC input voltage and frequency are detected different.	<ol style="list-style-type: none"> <li>1. Check the utility wiring connection and restart the inverter.</li> <li>2. Make sure utility starts up at same time. If there are breakers installed between utility and inverters, please be sure all breakers can be turned on AC input at same time.</li> <li>3. If the problem remains, please contact your installer.</li> </ol>
85	AC output current unbalance	<ol style="list-style-type: none"> <li>1. Restart the inverter.</li> <li>2. Remove some excessive loads and re-check load information from LCD of inverters. If the values are different, please check if AC input and output cables are in the same length and material type.</li> <li>3. If the problem remains, please contact your installer.</li> </ol>
86	AC output mode setting is different.	<ol style="list-style-type: none"> <li>1. Switch off the inverter and check LCD setting #28.</li> <li>2. For parallel system in single phase, make sure no 3P1, 3P2 or 3P3 is set on #28. For supporting three-phase system, make sure no "PAL" is set on #28.</li> <li>3. If the problem remains, please contact your installer.</li> </ol>

## Appendix II: Approximate Back-up Time Table

Model	Load (VA)	Backup Time @ 48Vdc 200Ah (min)	Backup Time @ 48Vdc 400Ah (min)
5KW	500	1226	2576
	1000	536	1226
	1500	316	804
	2000	222	542
	2500	180	430
	3000	152	364
	3500	130	282
	4000	100	224
	4500	88	200
	5000	80	180

**Note:** Backup time depends on the quality of the battery, age of battery and type of battery.  
Specifications of batteries may vary depending on different manufacturers.